

Серия «Папка дошкольника»

Посчитаем до 10

Знакомство с цифрами до 10

Для
детей
3-5
лет



Солнечные
ступеньки®

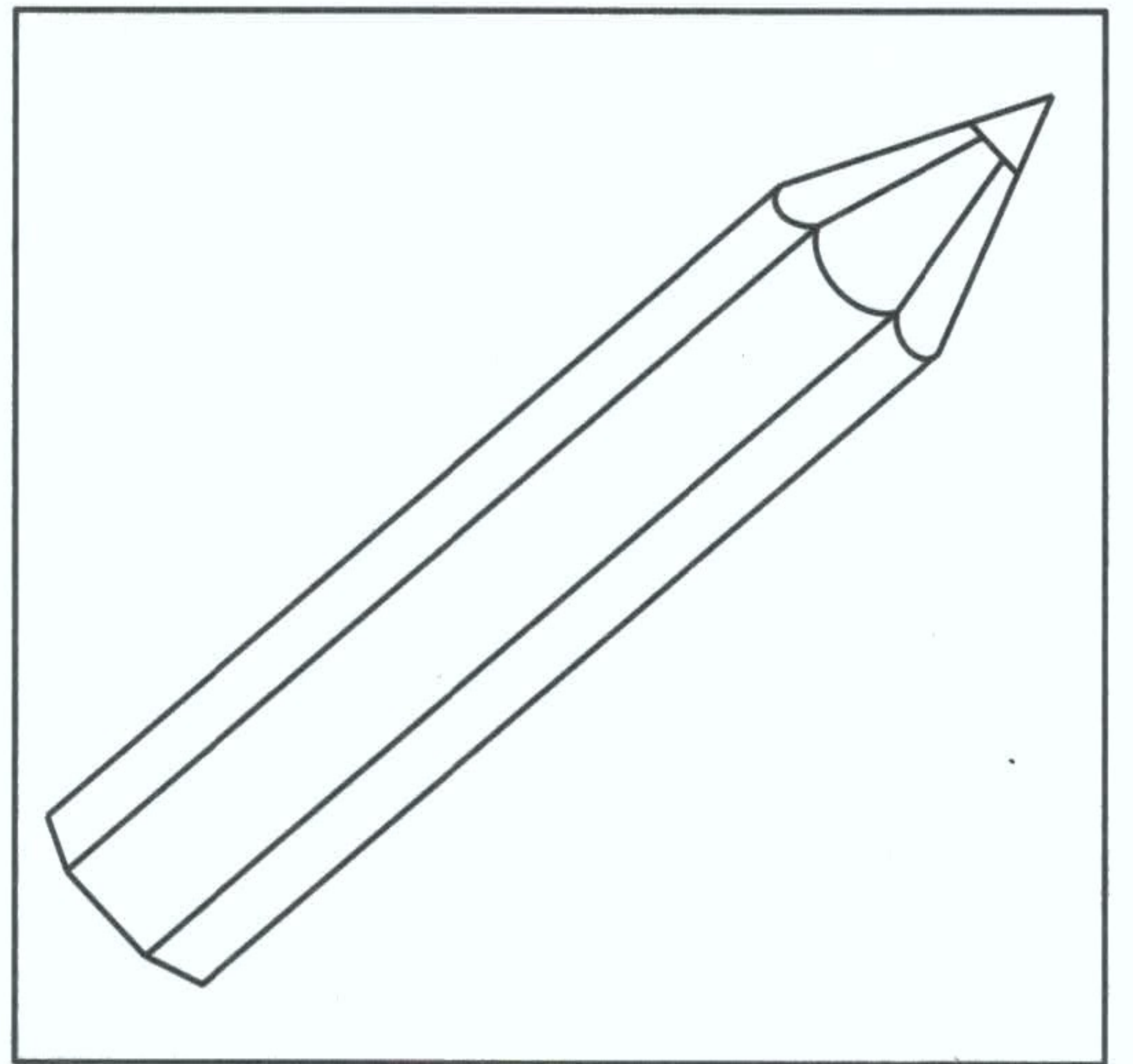
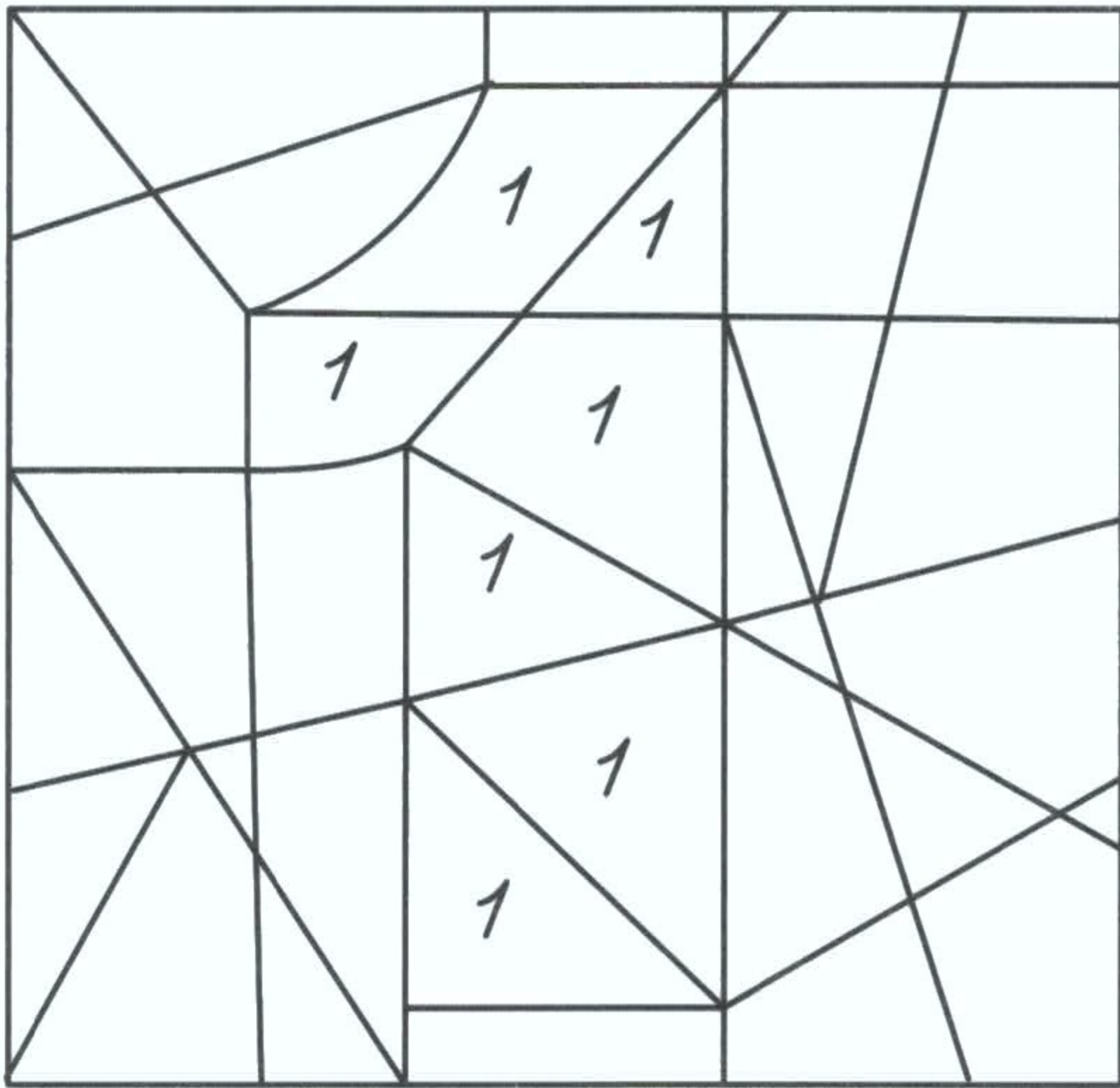
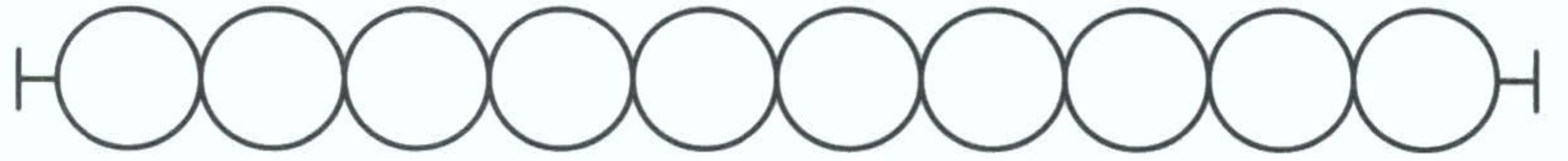
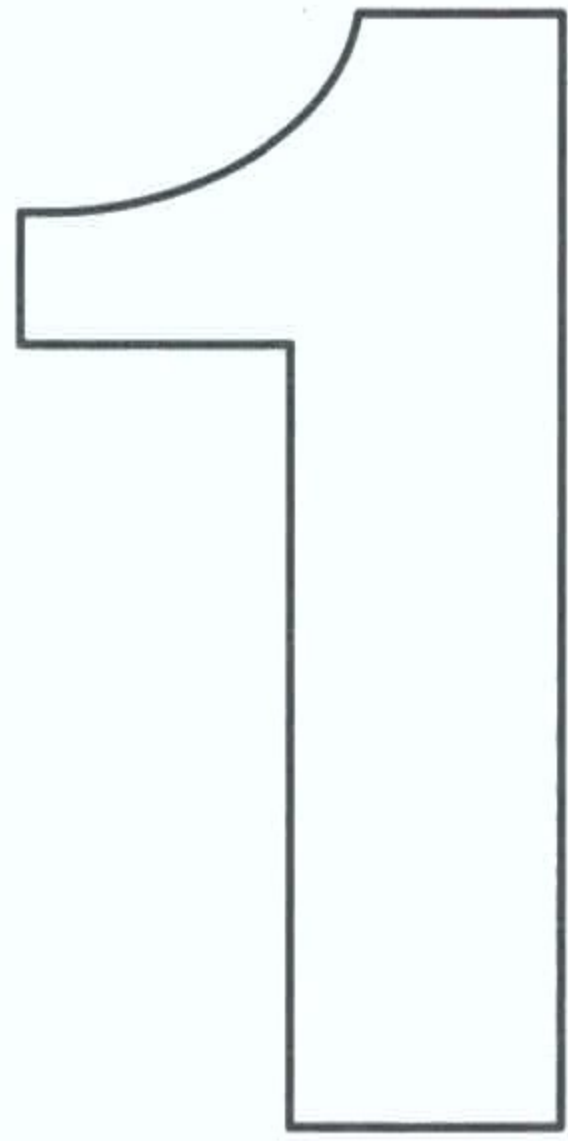

Найди и раскрась предметы, которых по одному.

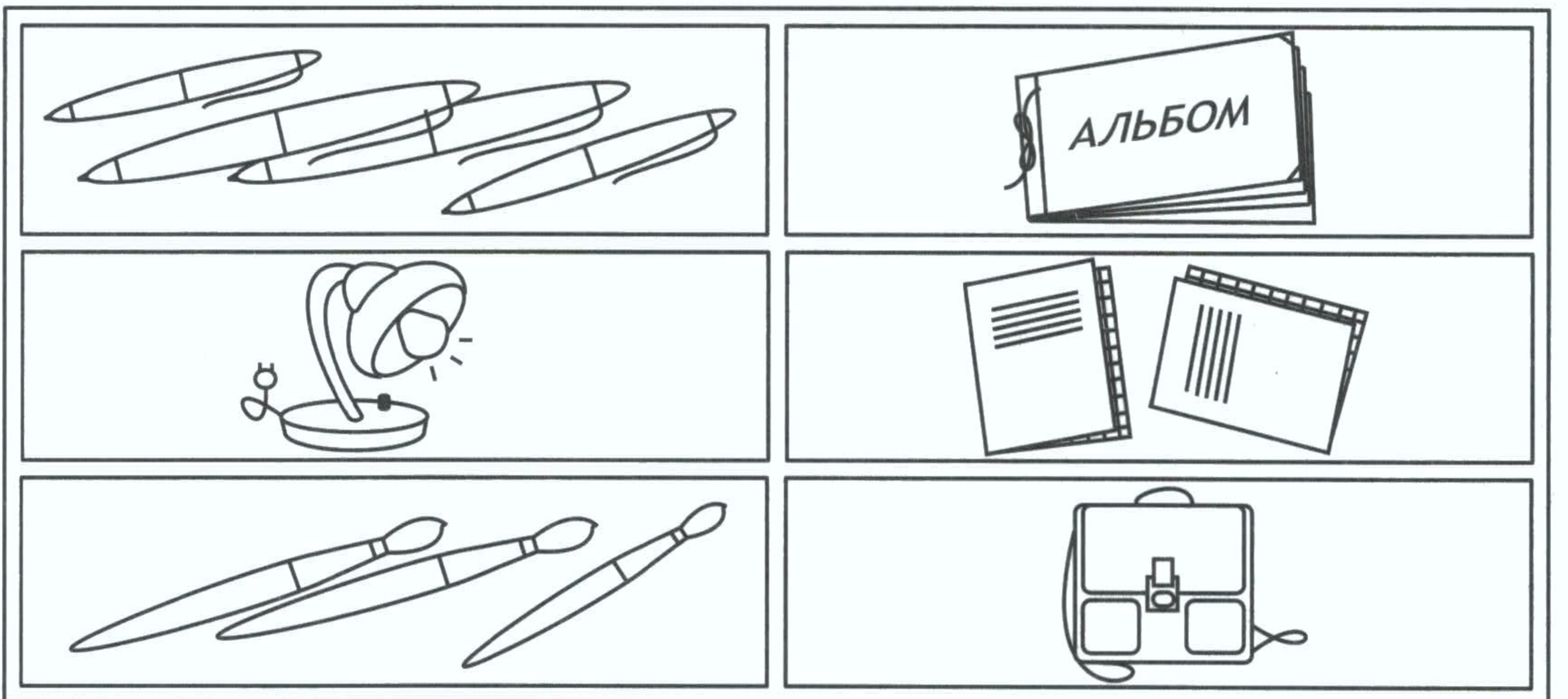

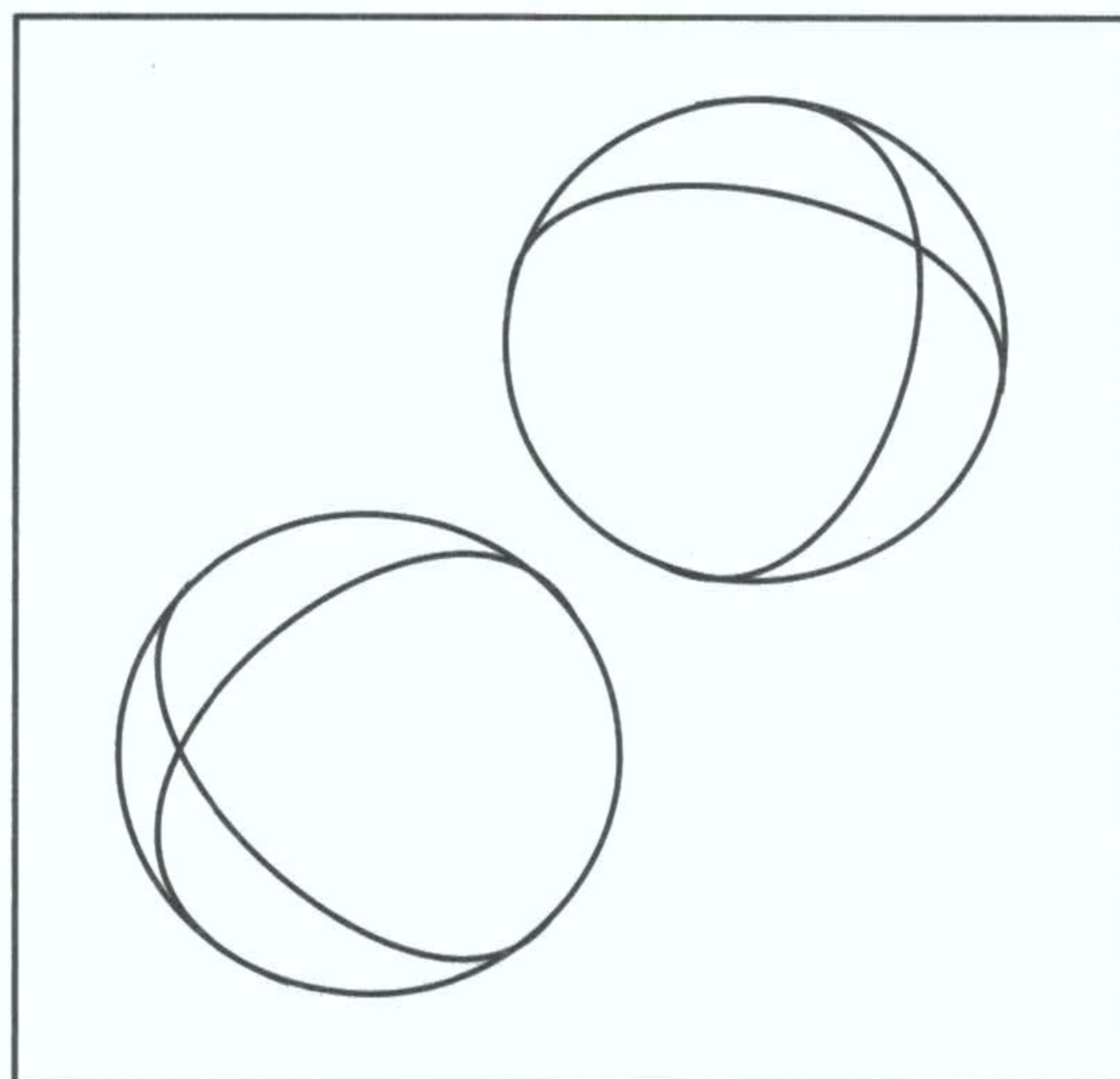
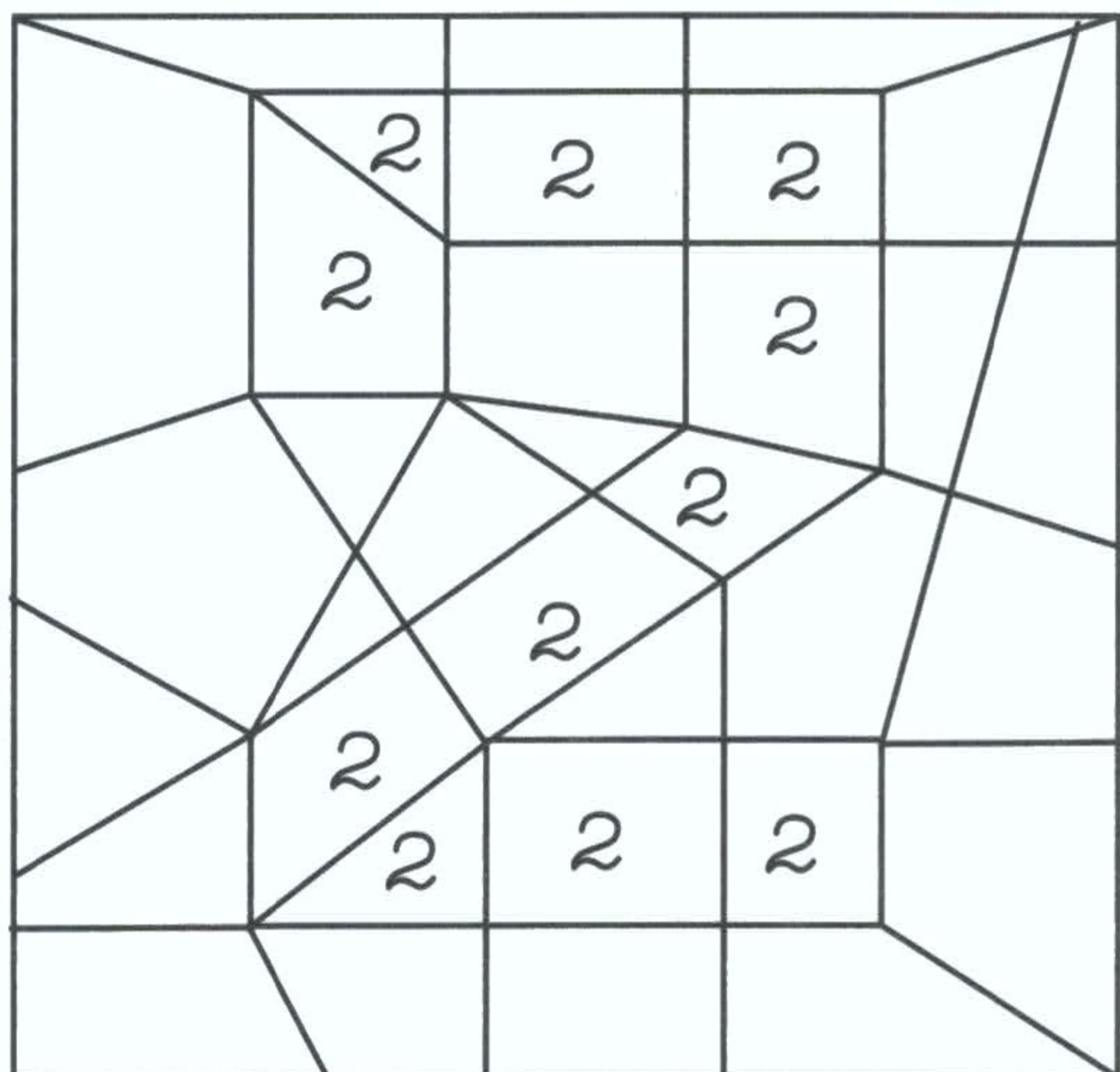
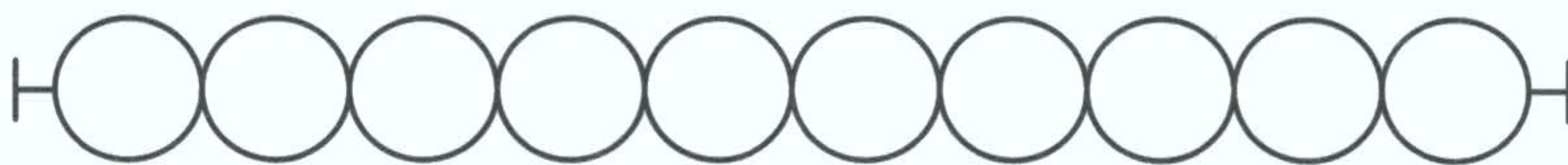

Сколько предметов на рисунке? Напиши.

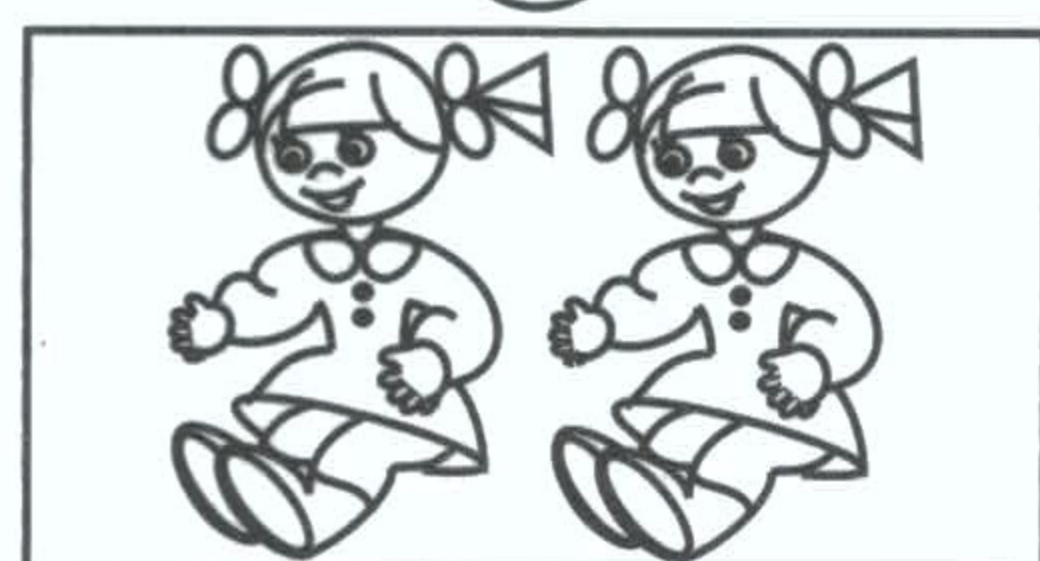
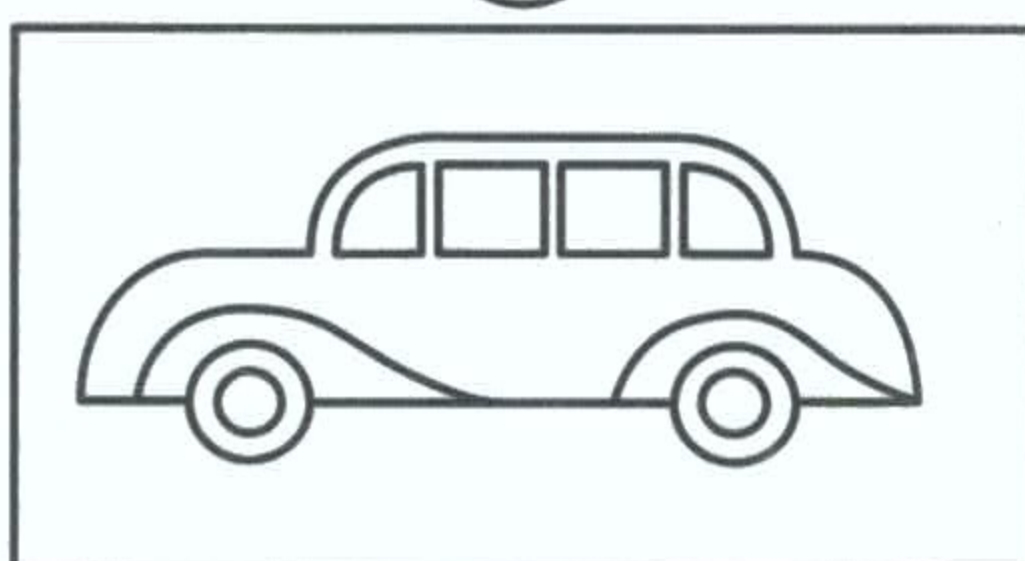
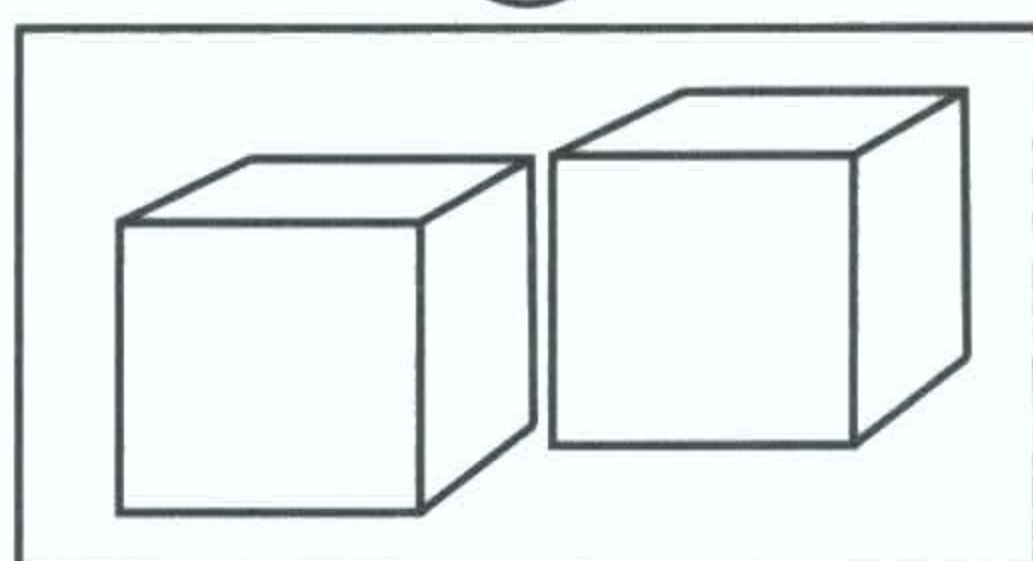
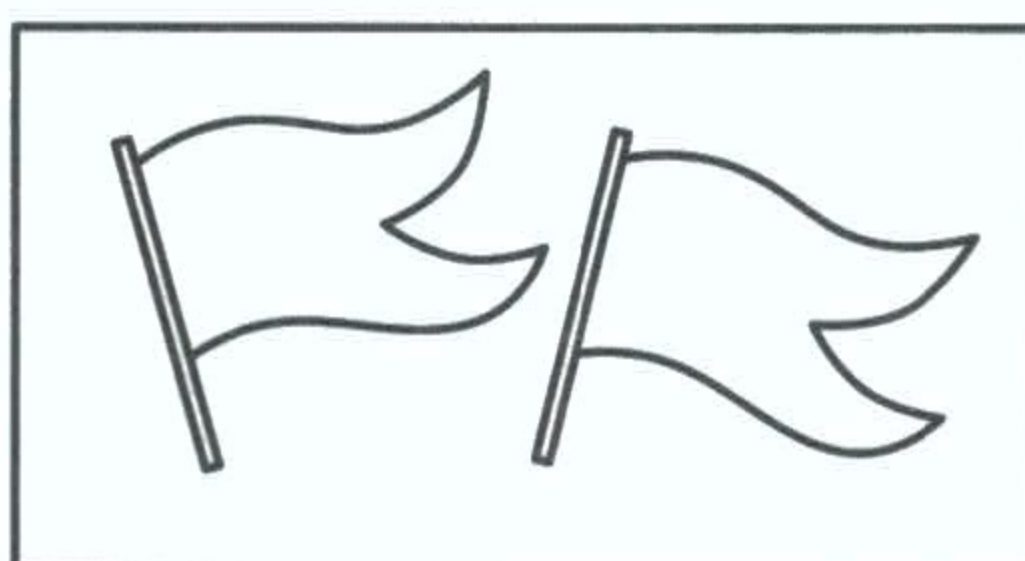

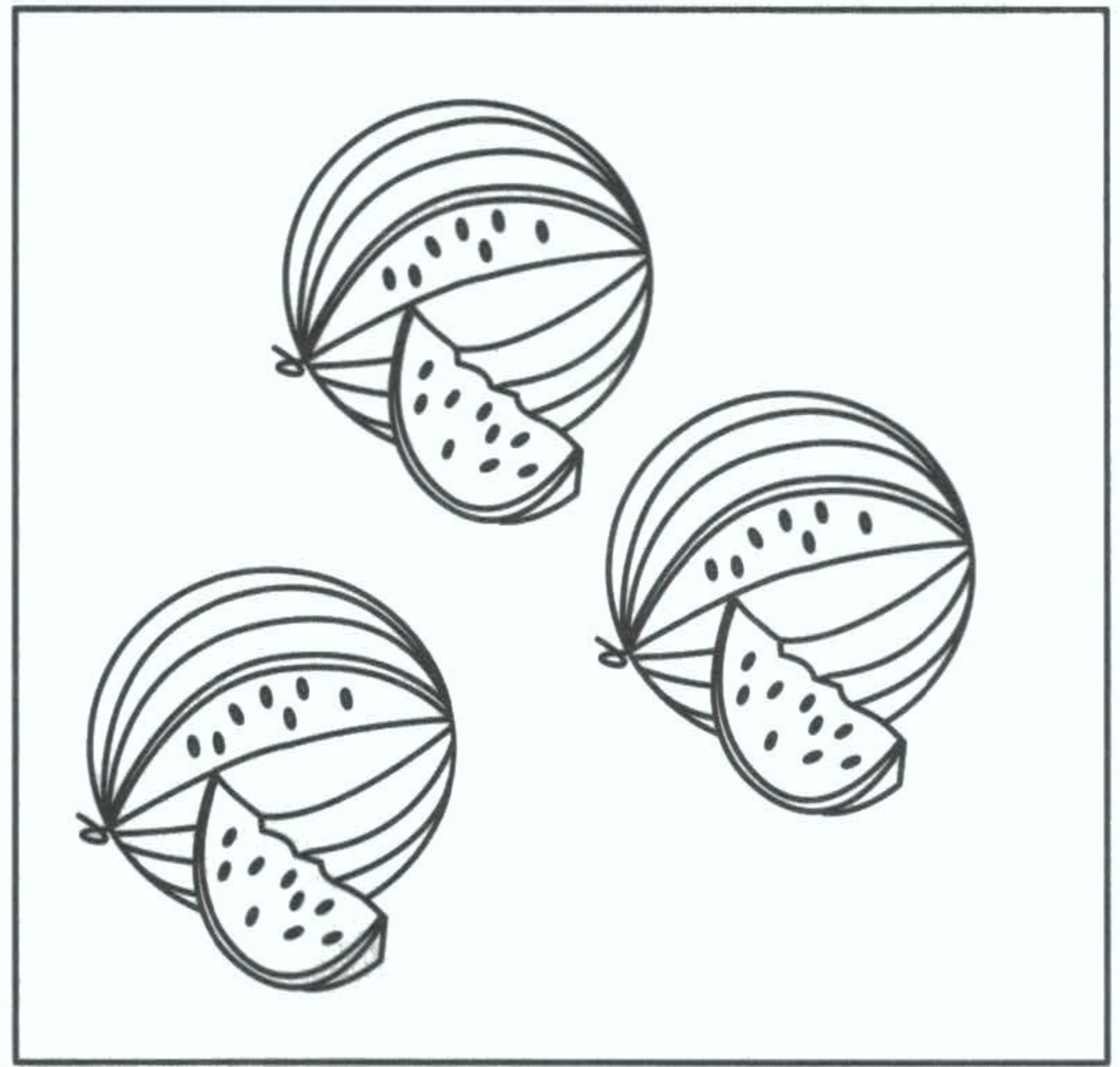
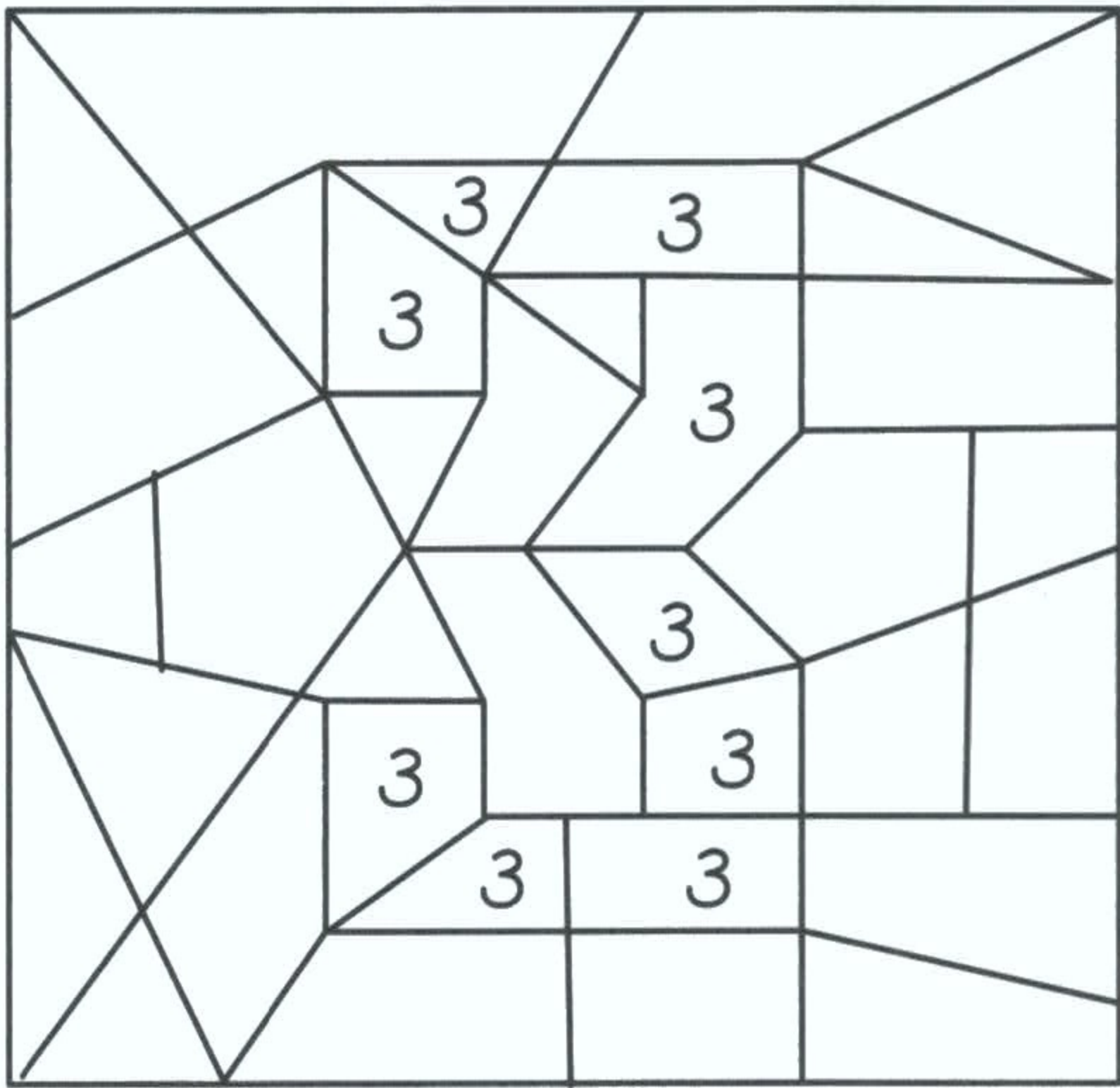
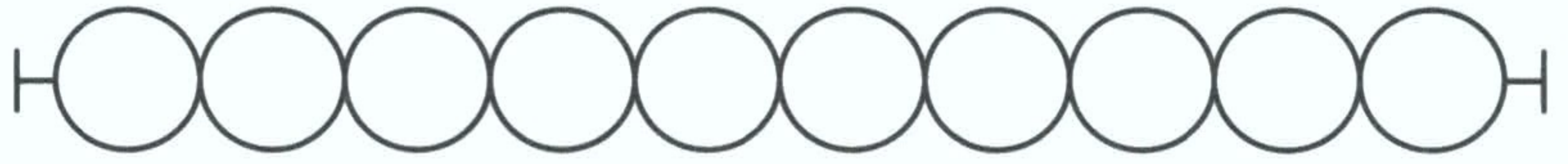

Сосчитай, сколько в вазе яблок, груш, бананов?
Напиши цифру.



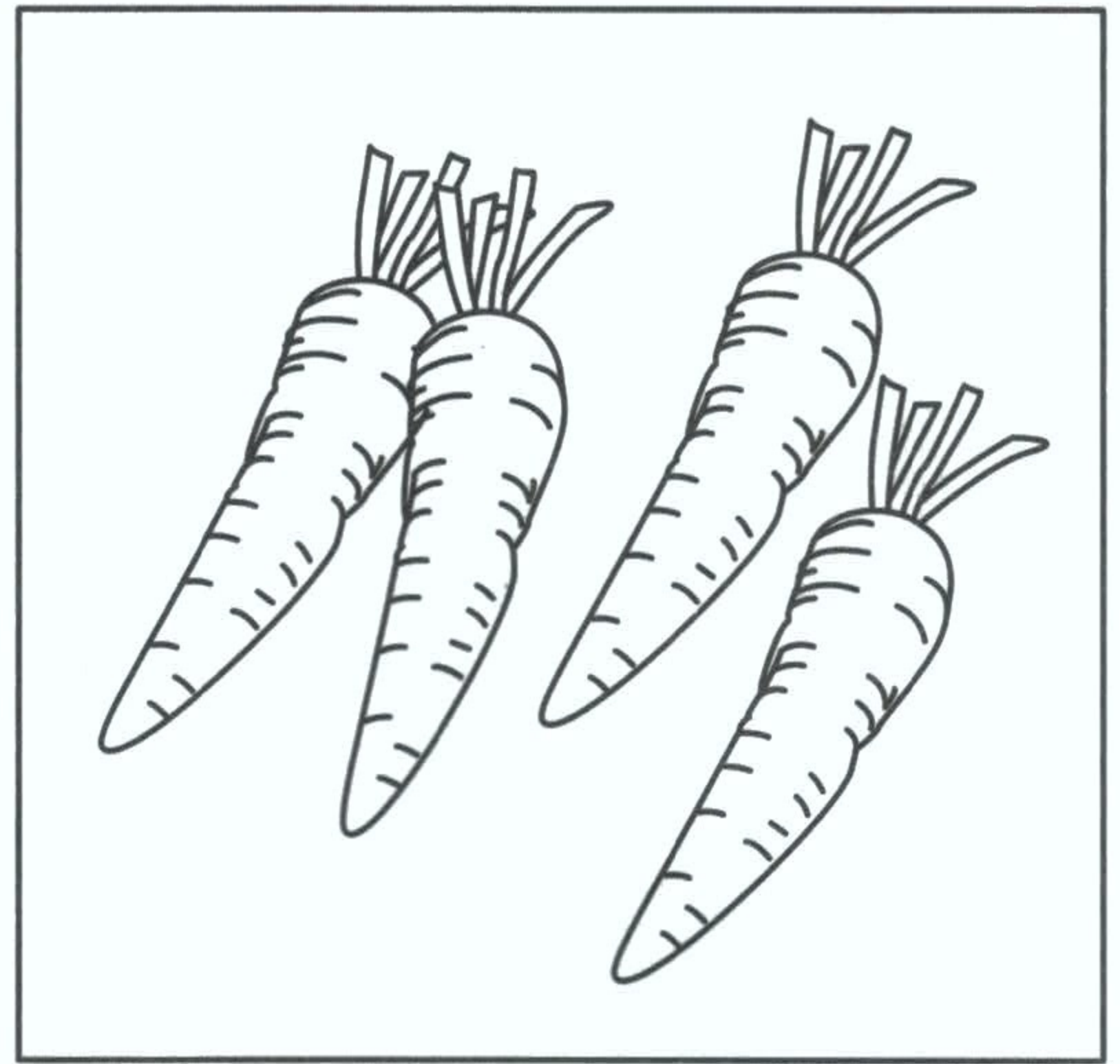
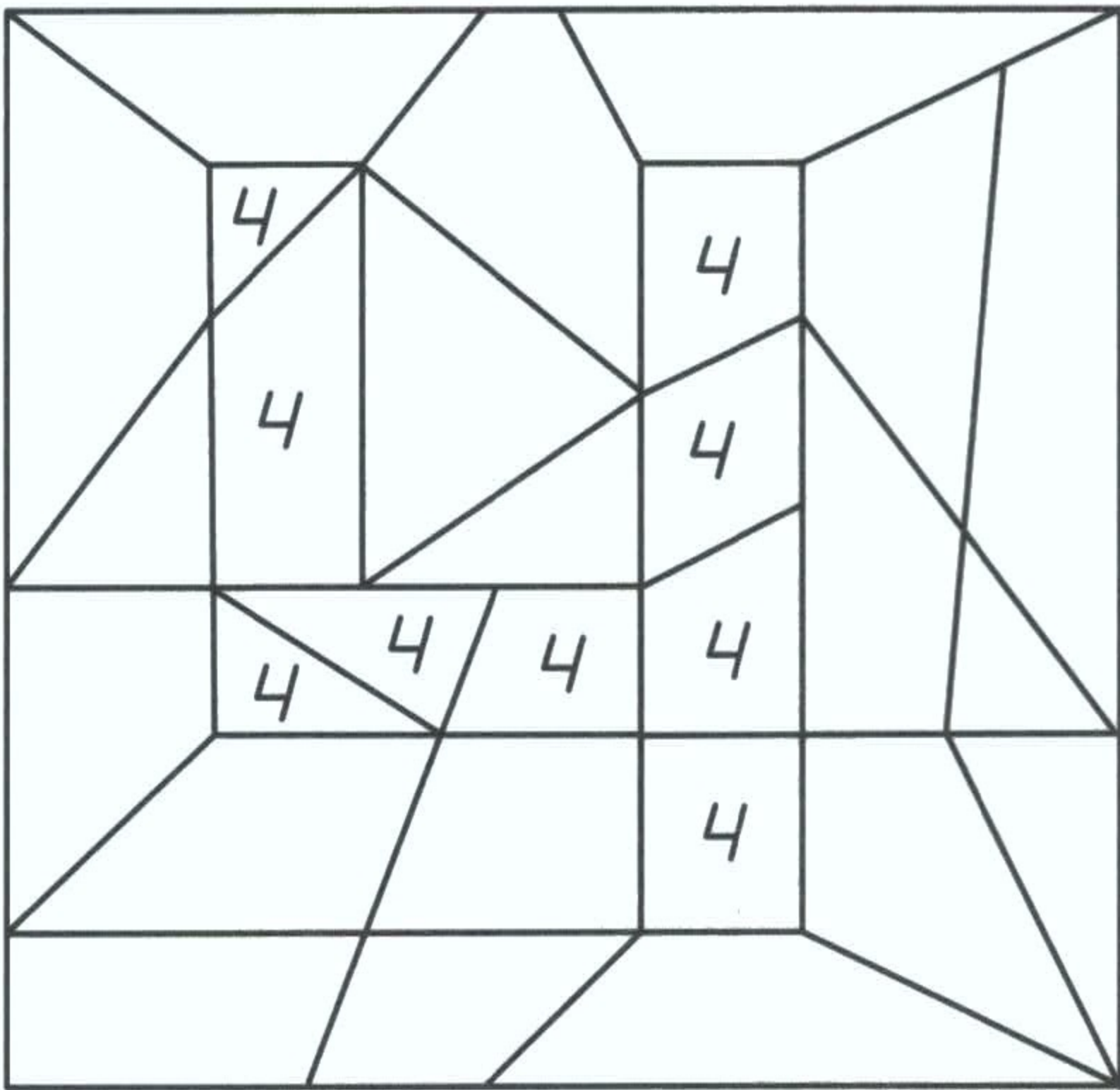
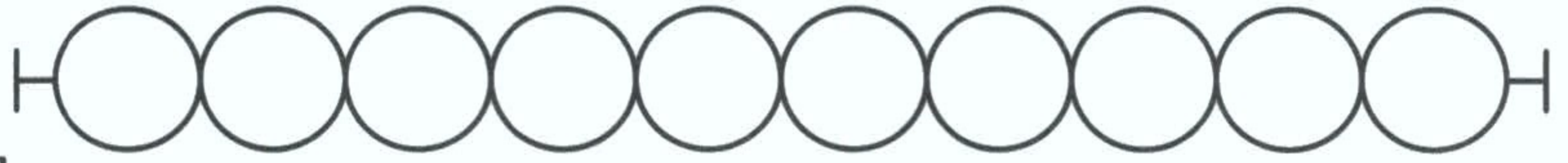
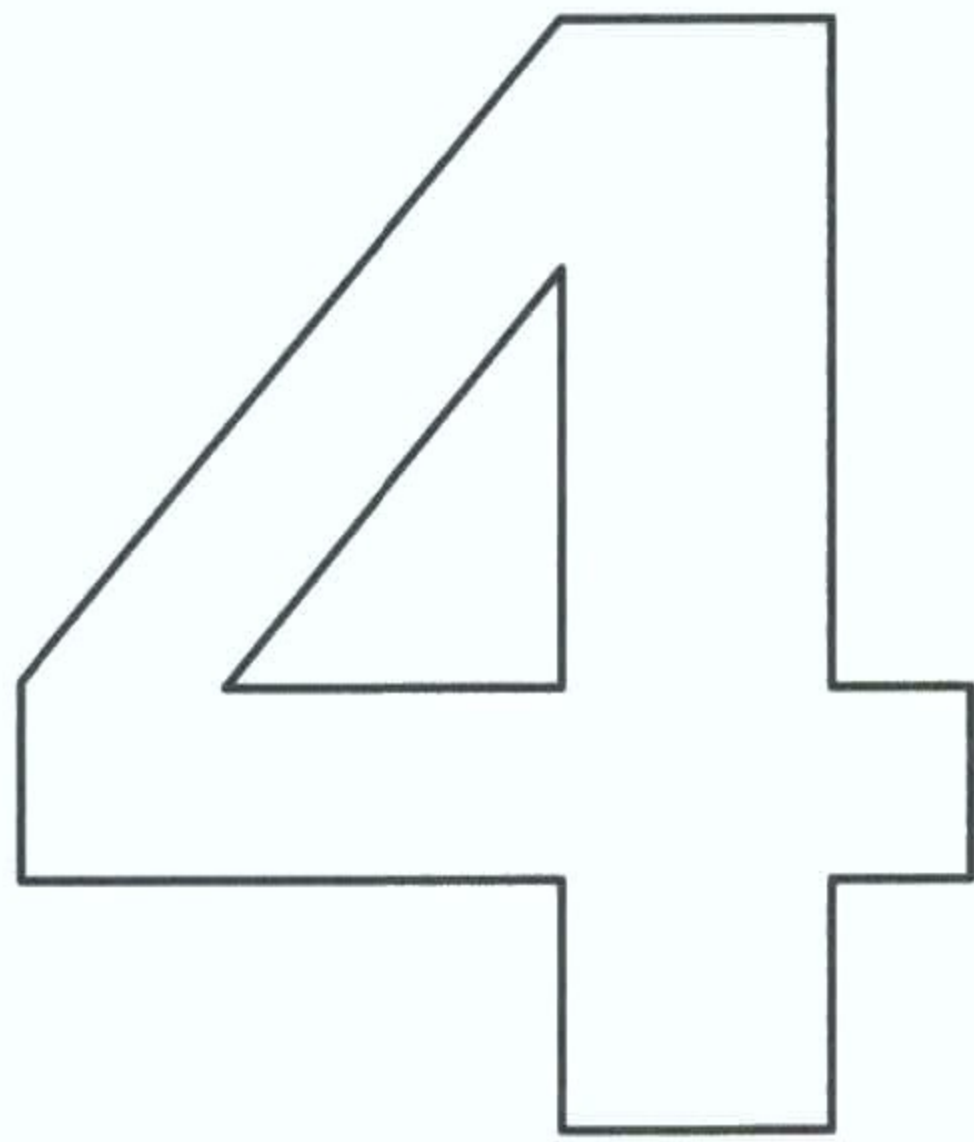

Дорисуй в каждом круге столько овощей, чтобы их стало по четыре.

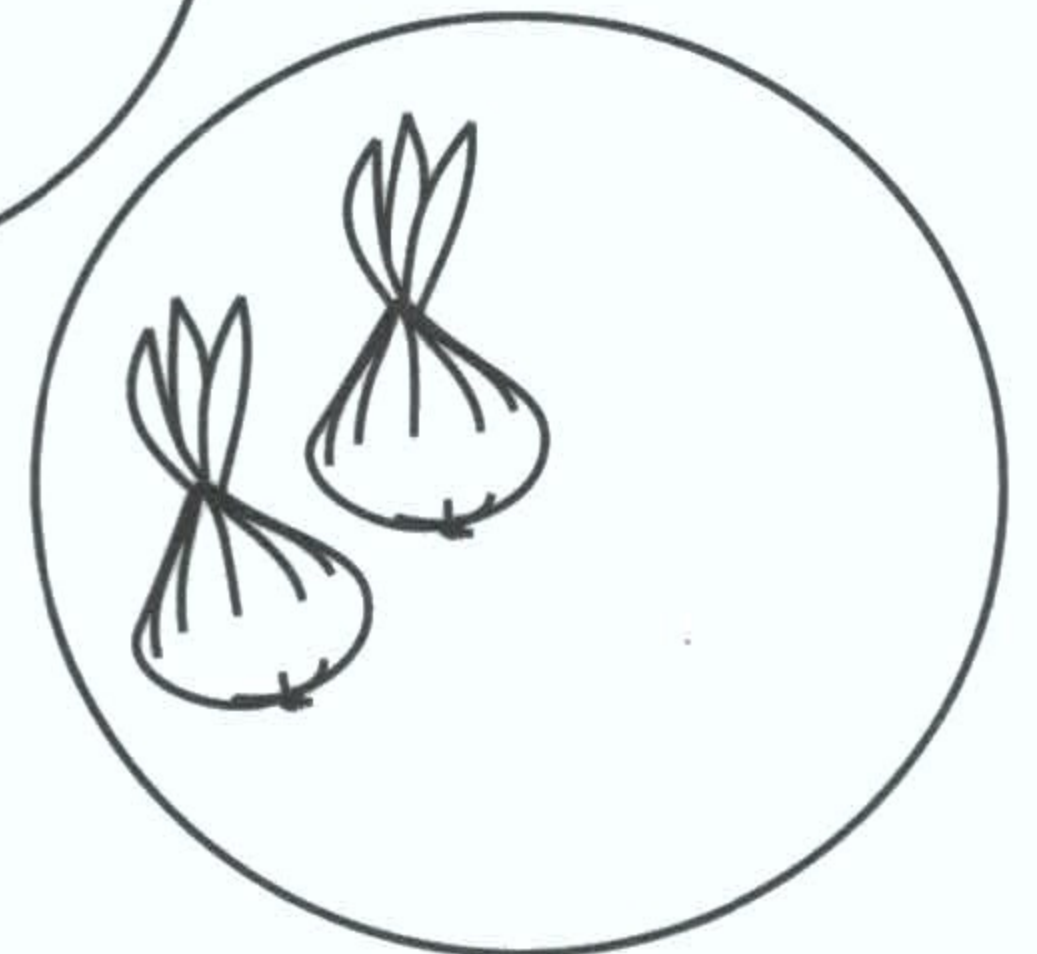
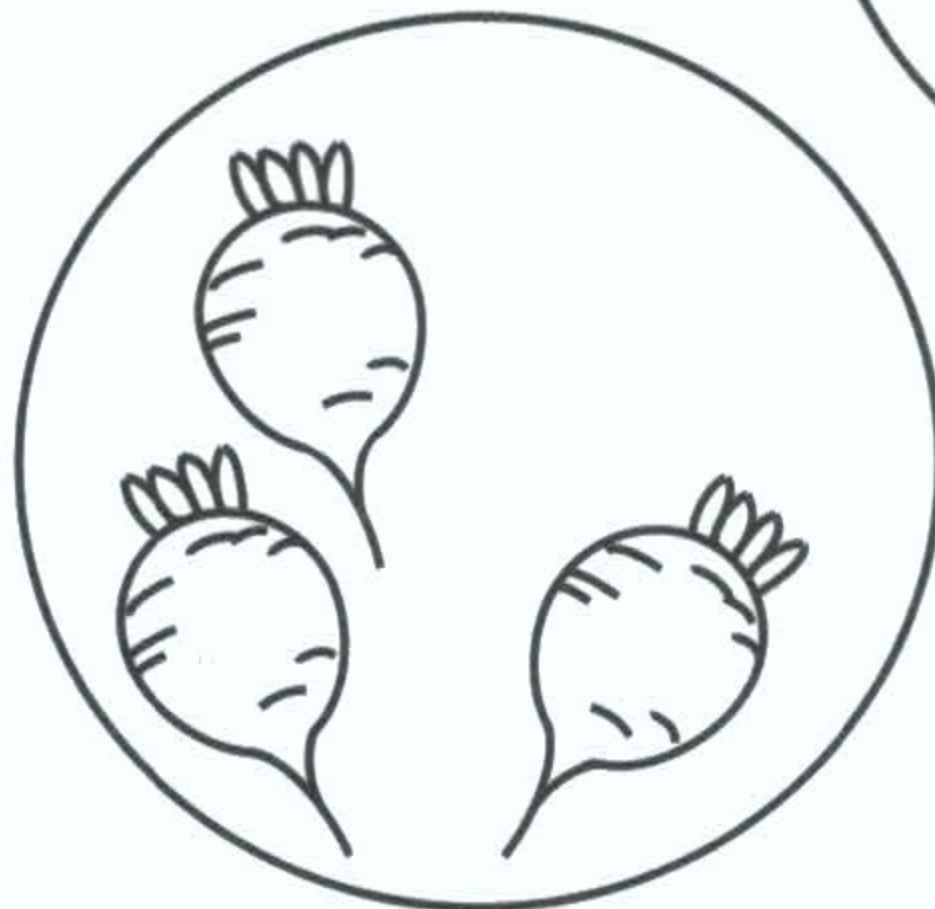
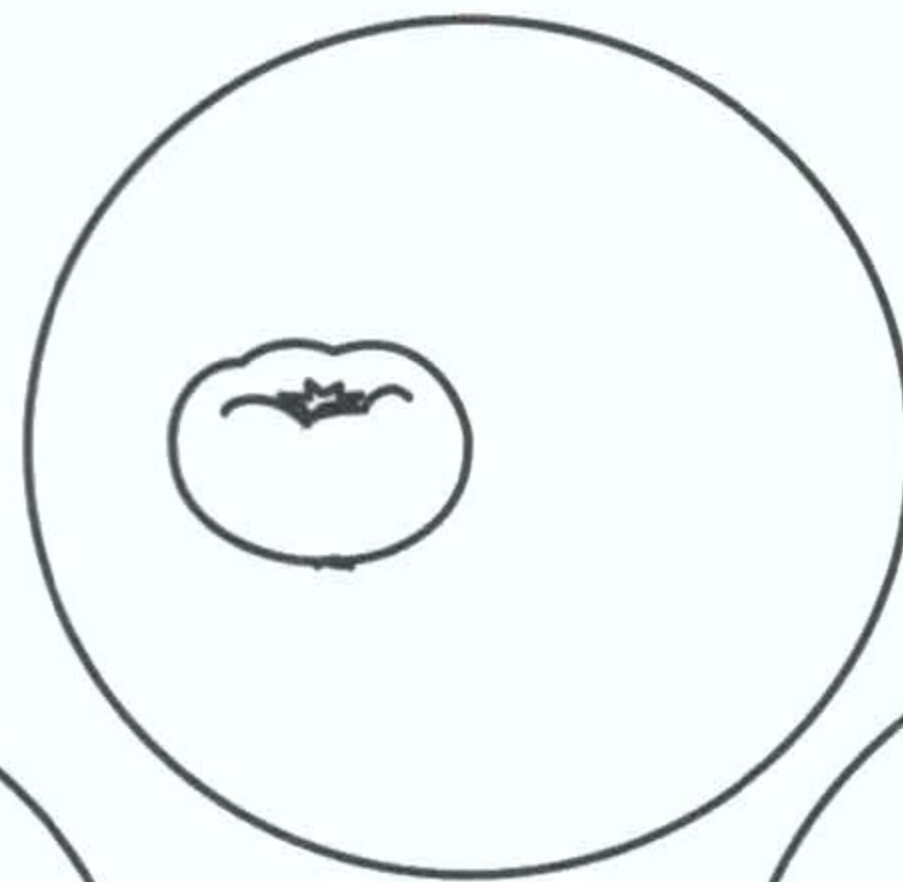
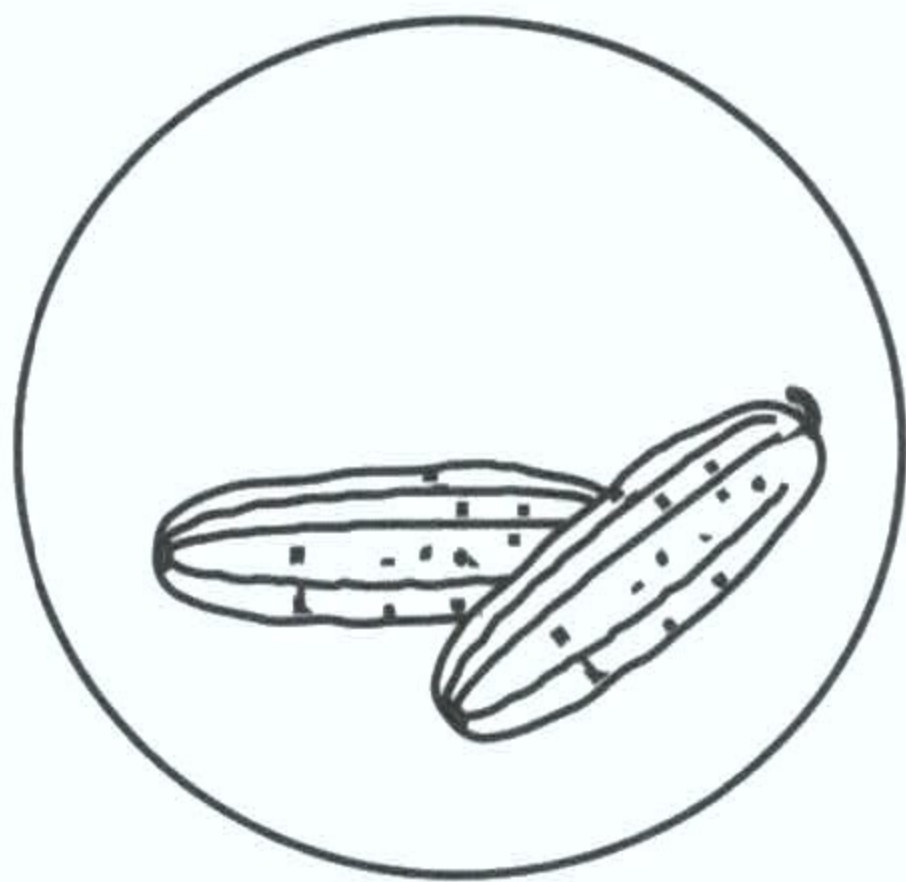

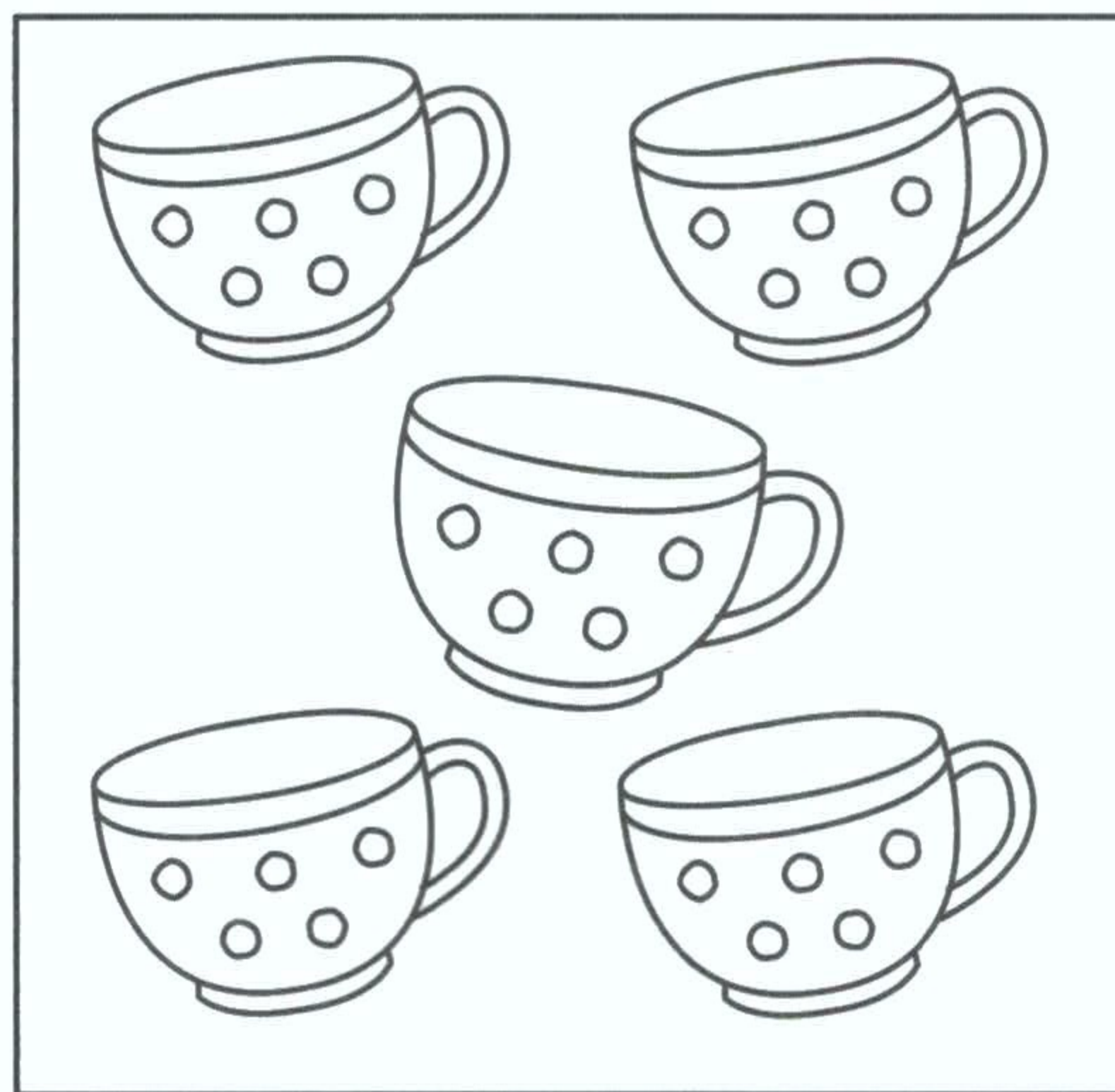
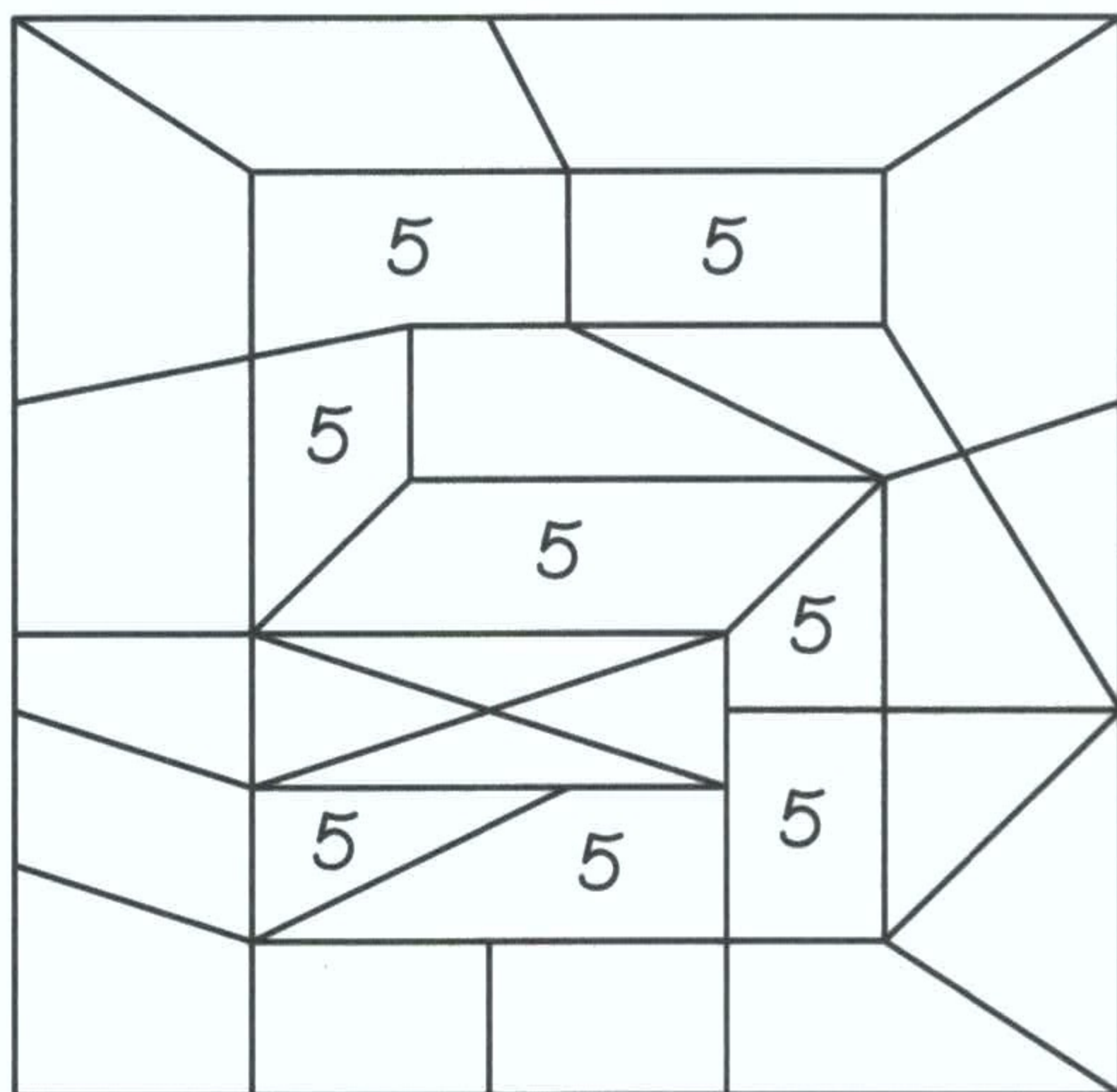

Раскрась столько предметов, сколько обозначено цифрой.



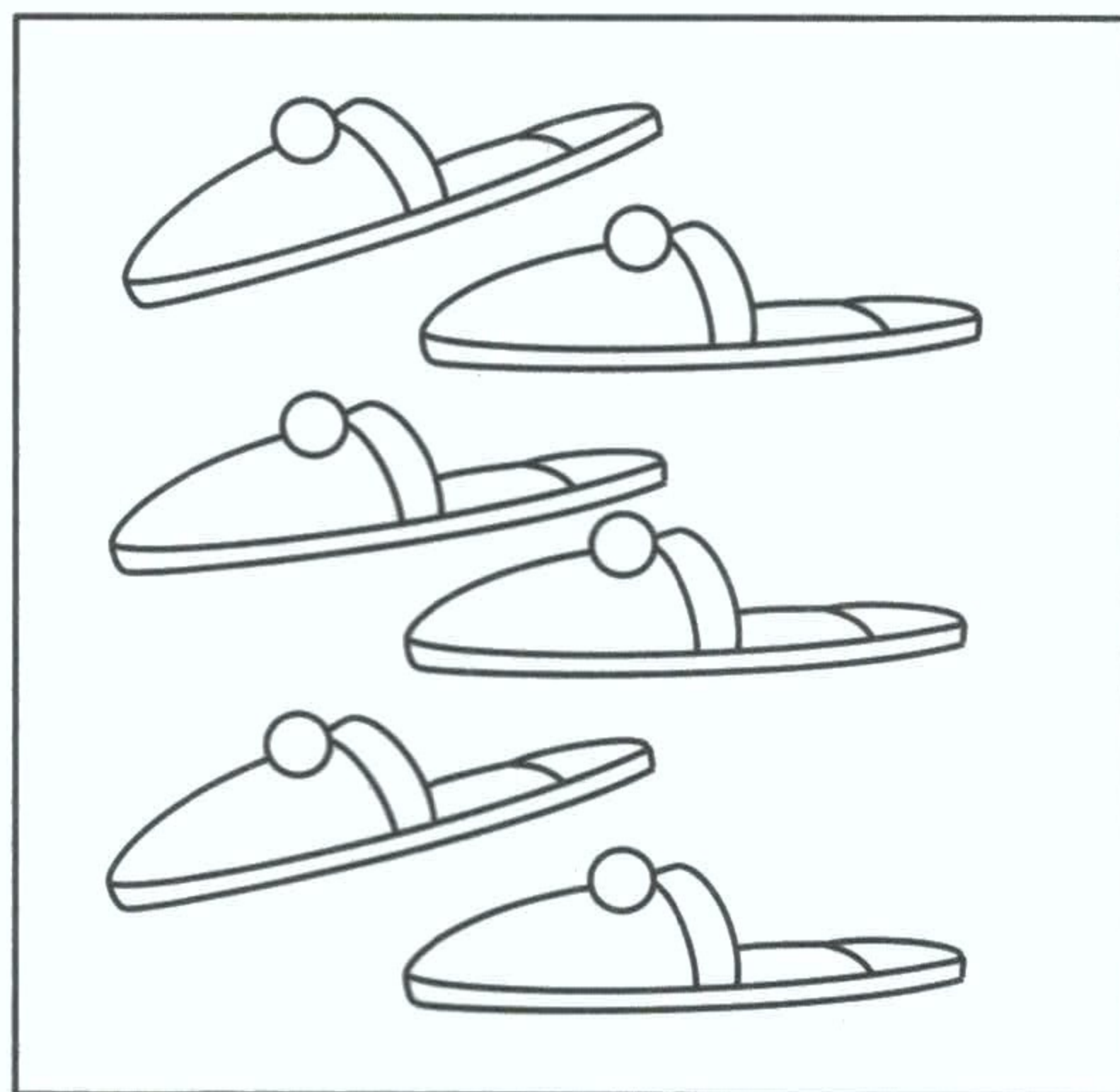
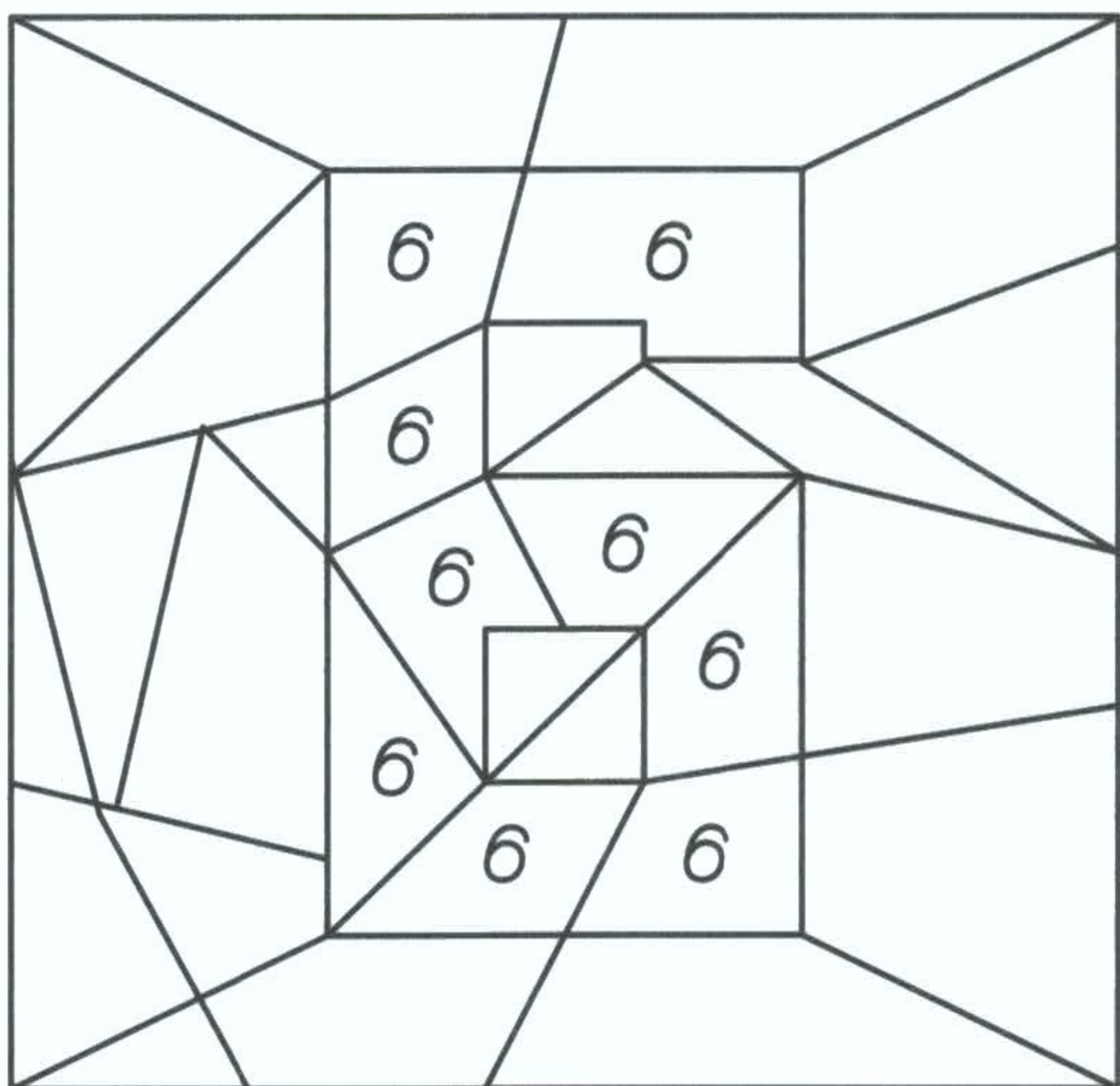
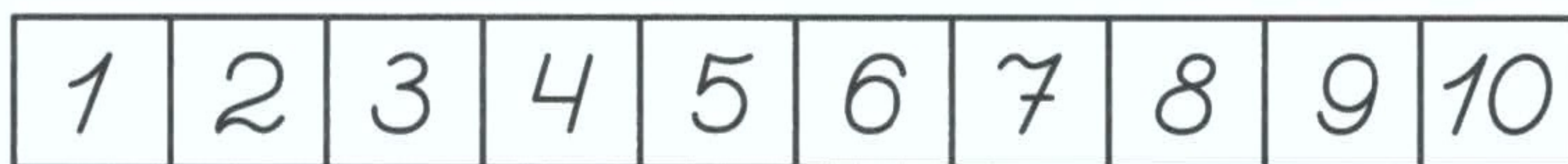
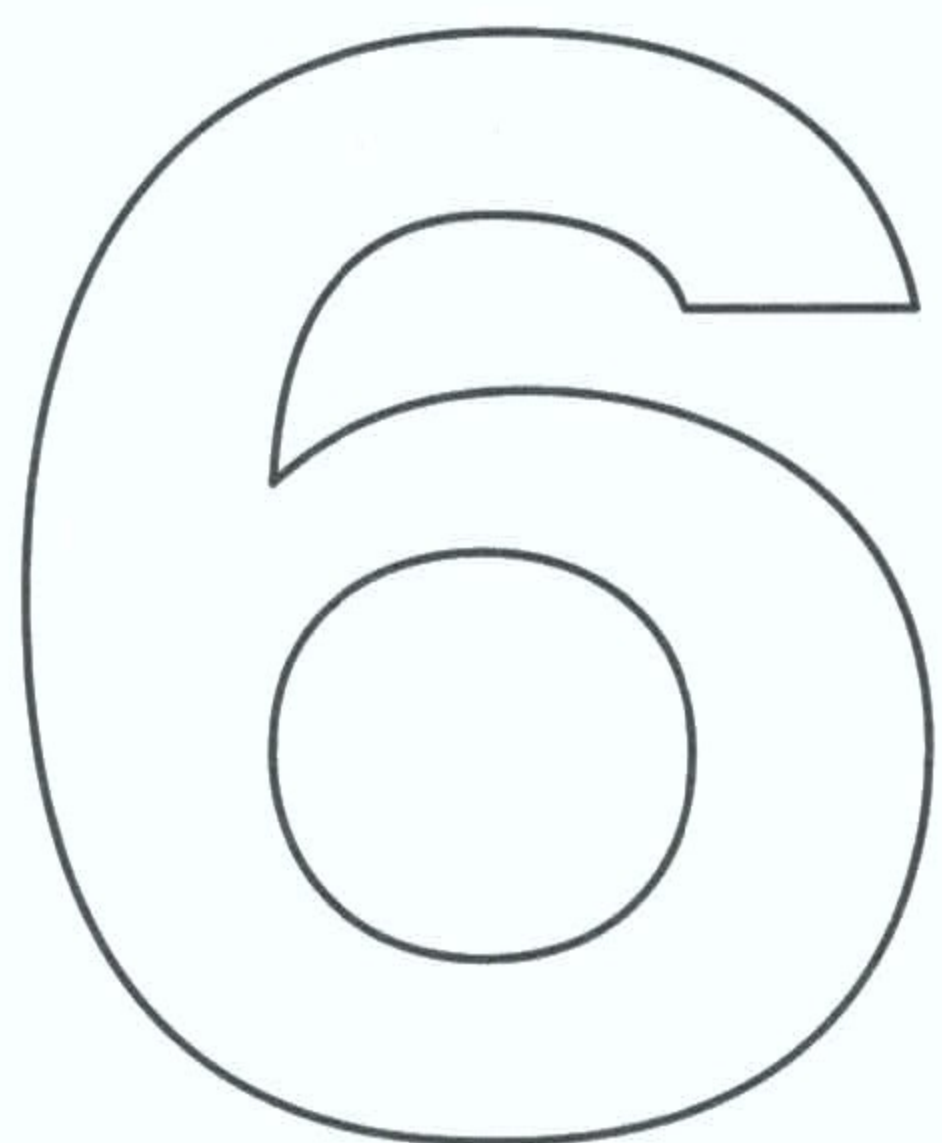

Раскрась только то, про что можно сказать, что их шесть.



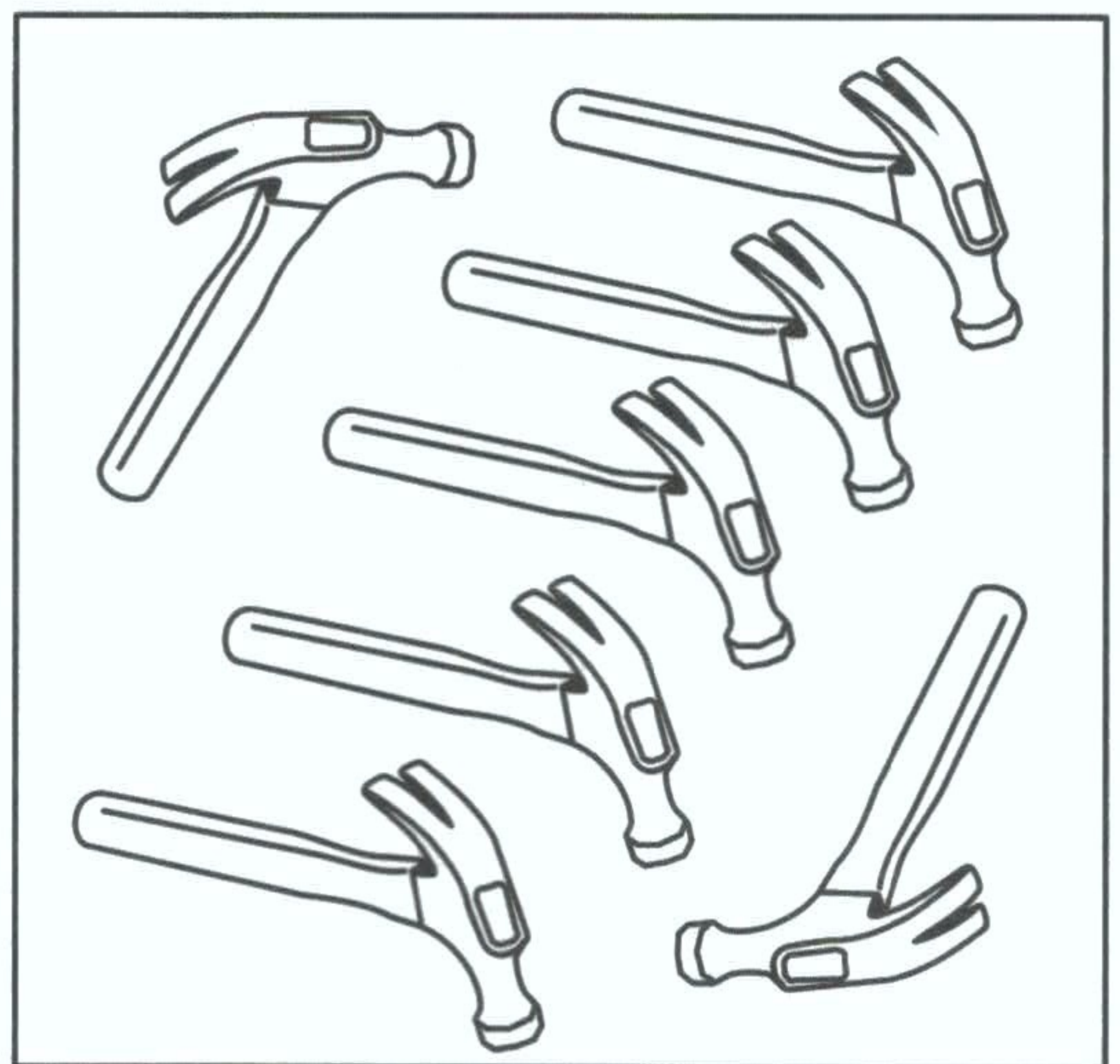
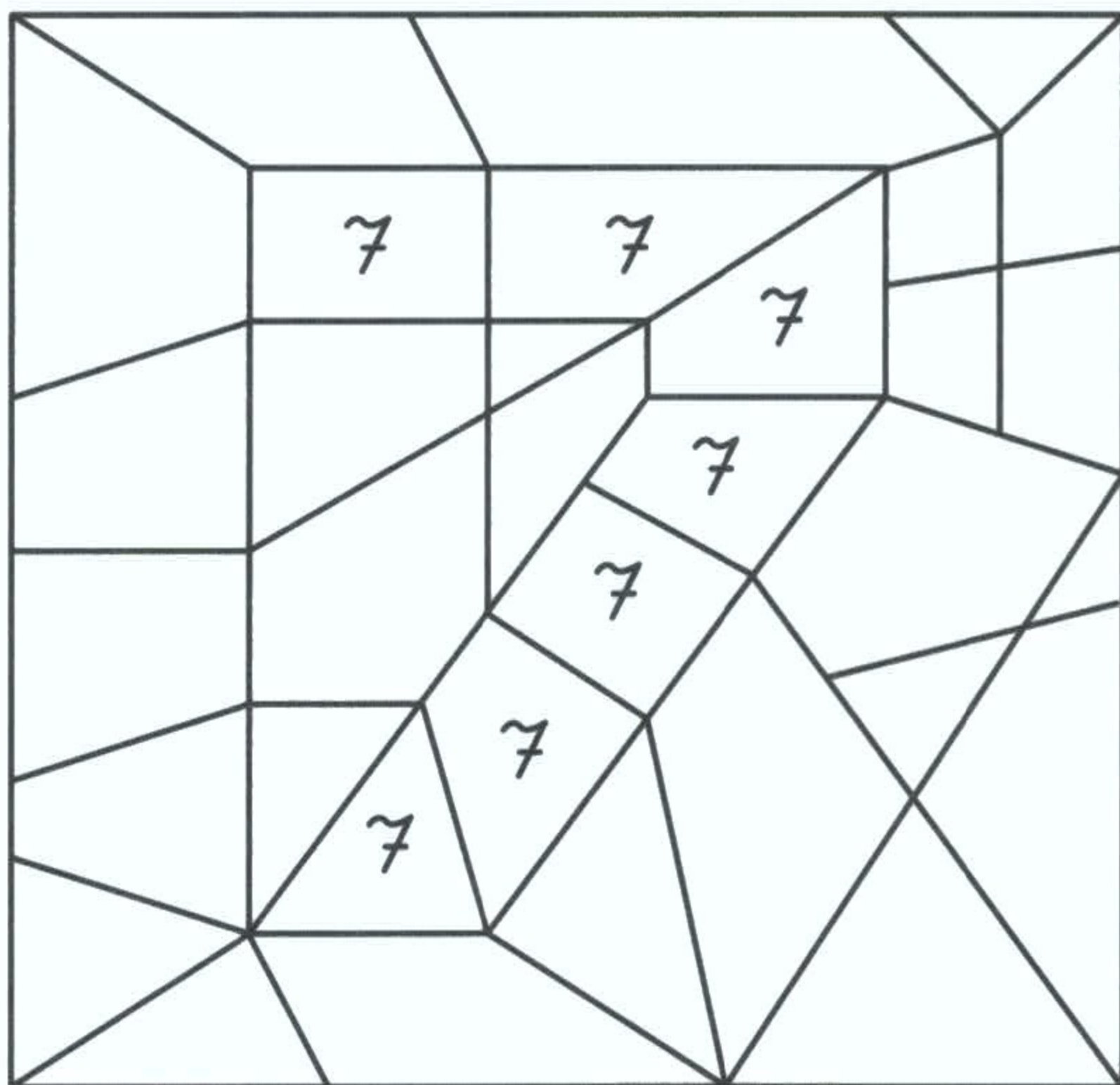
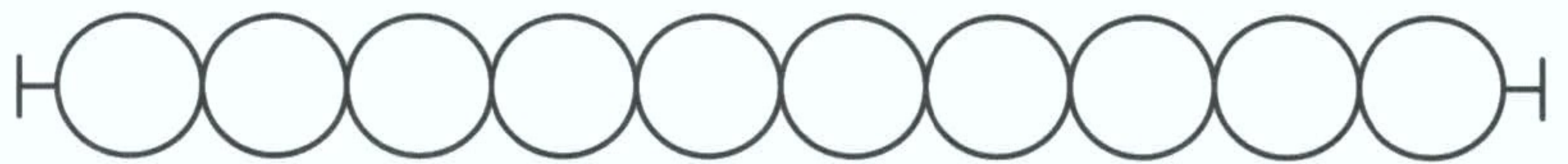
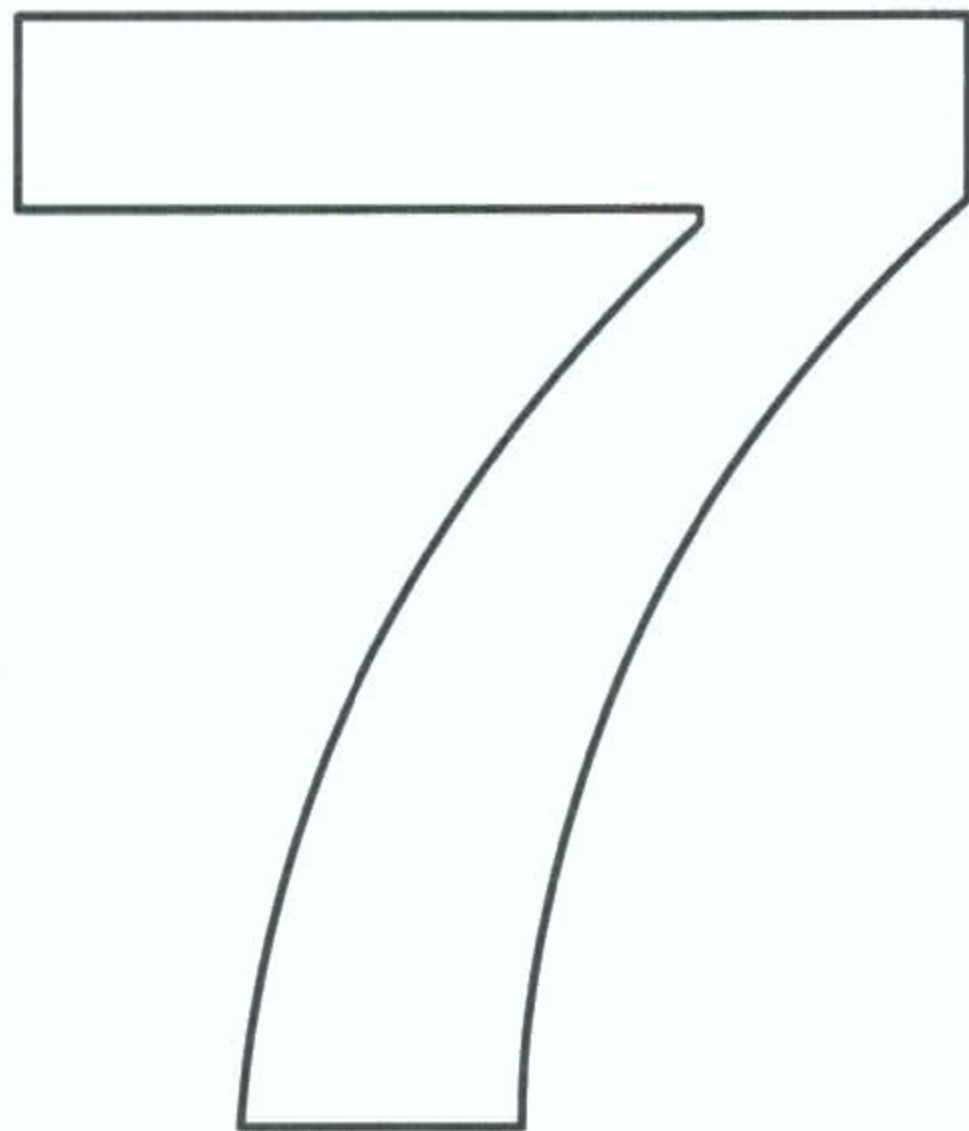

Зачеркни овал, где инструментов не семь.

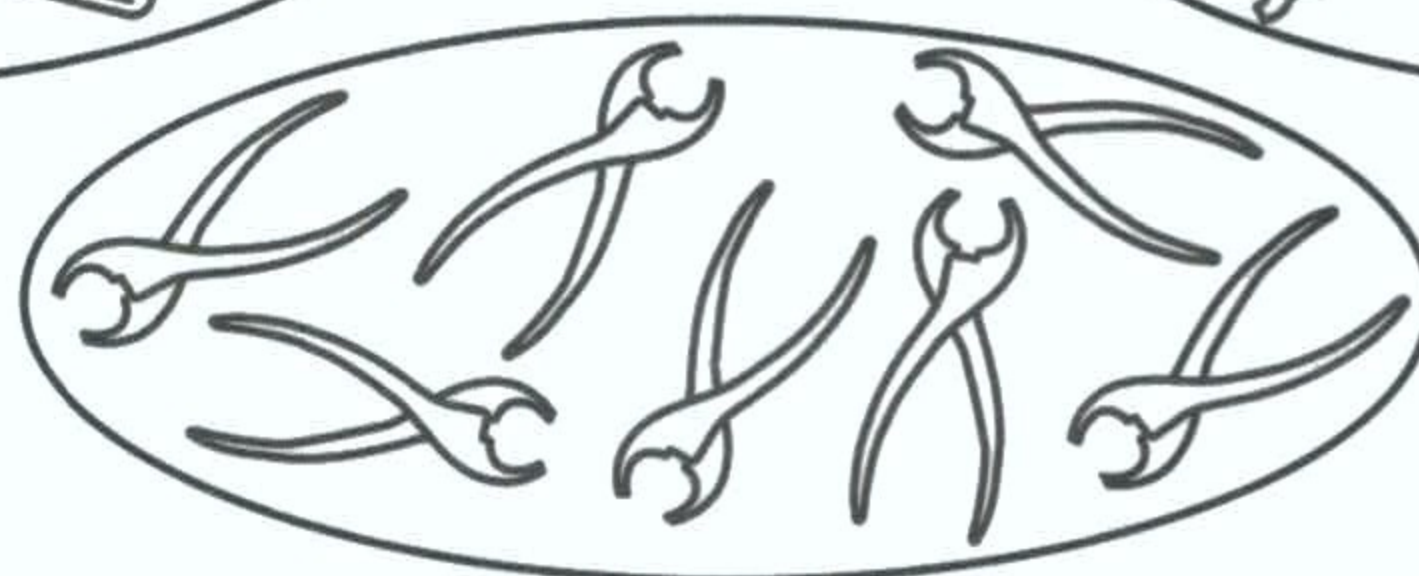
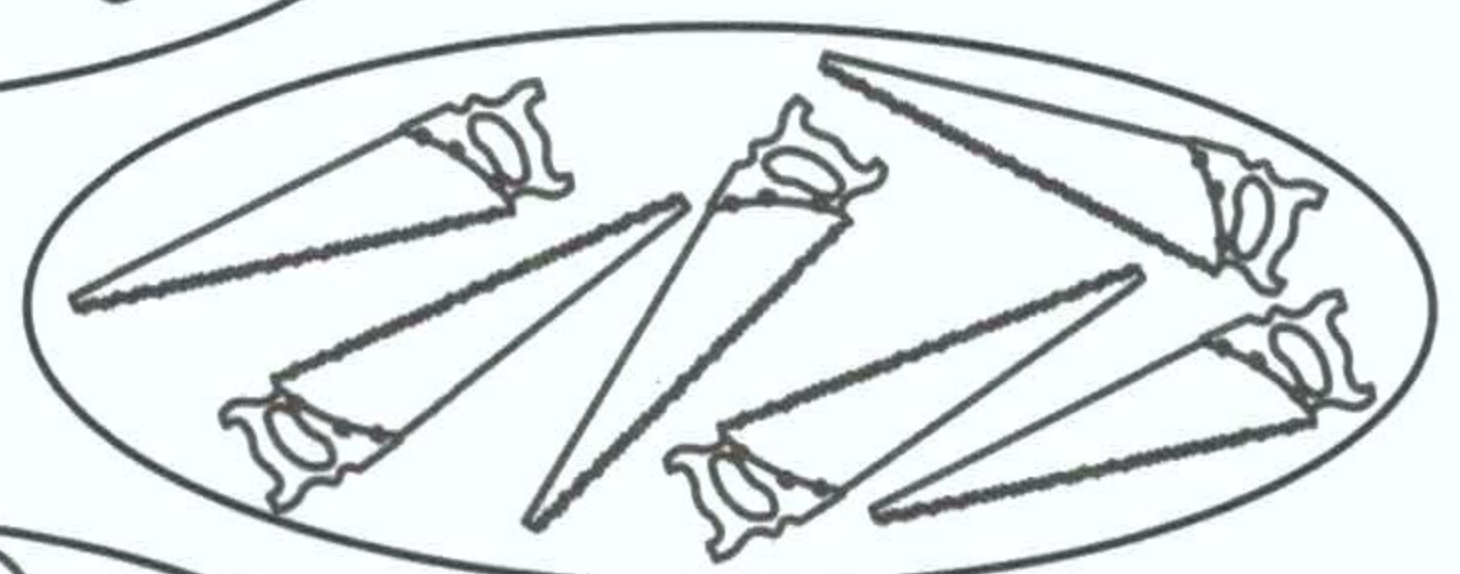
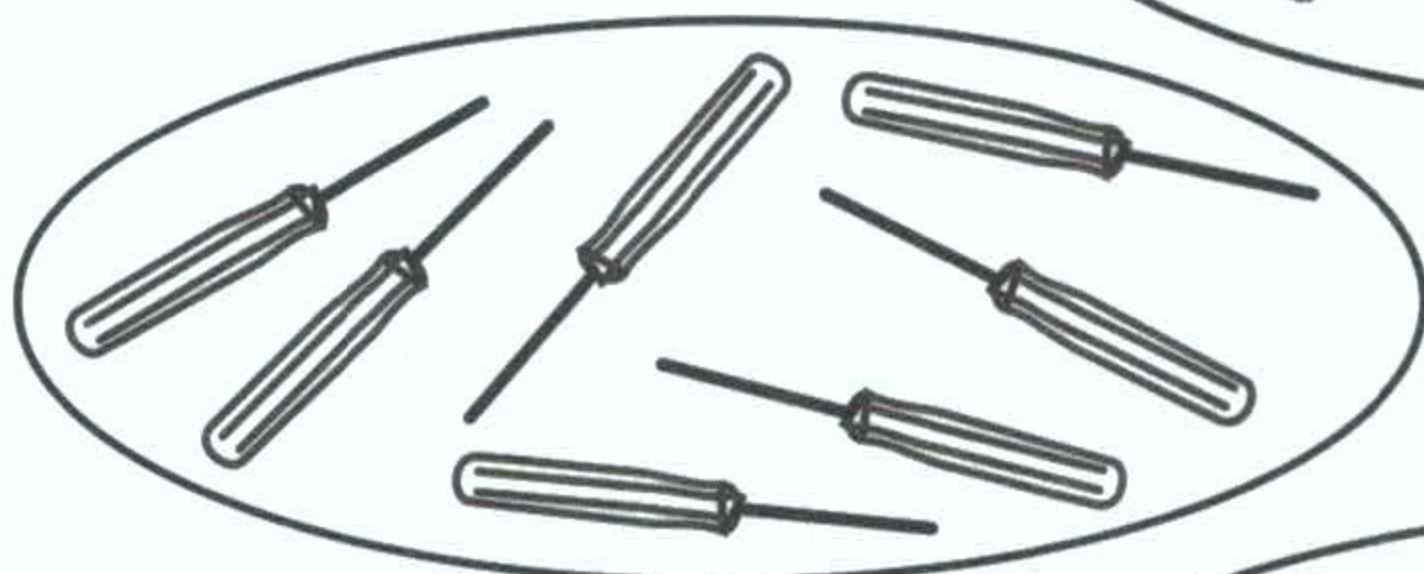
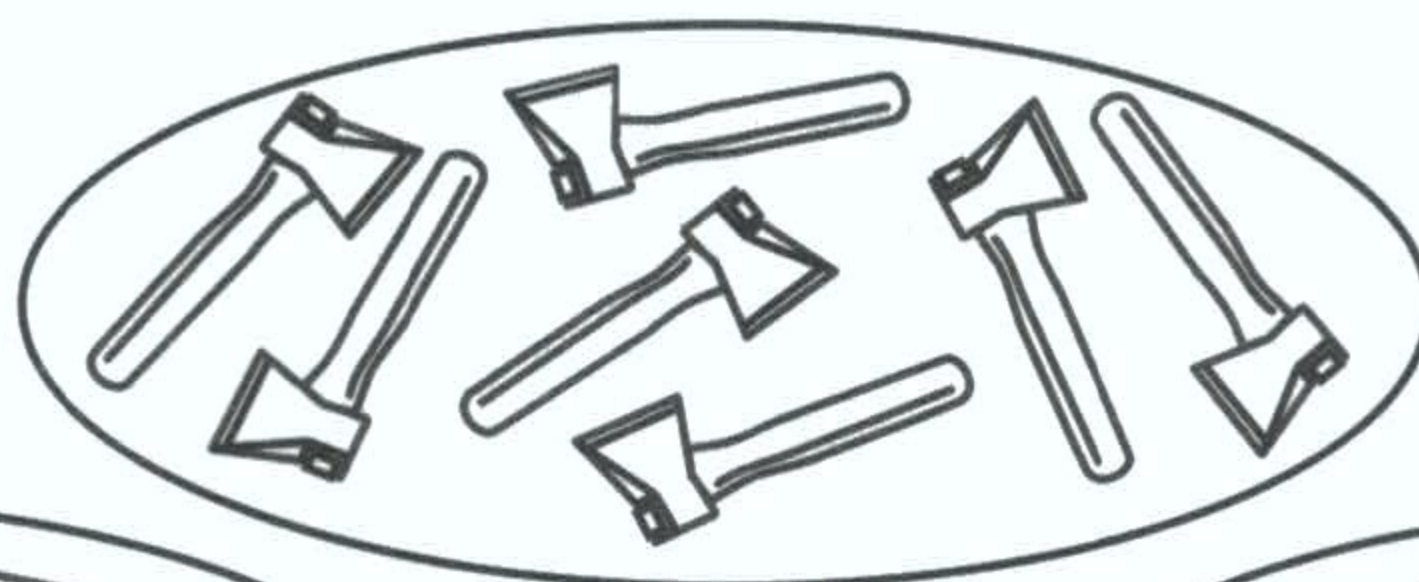

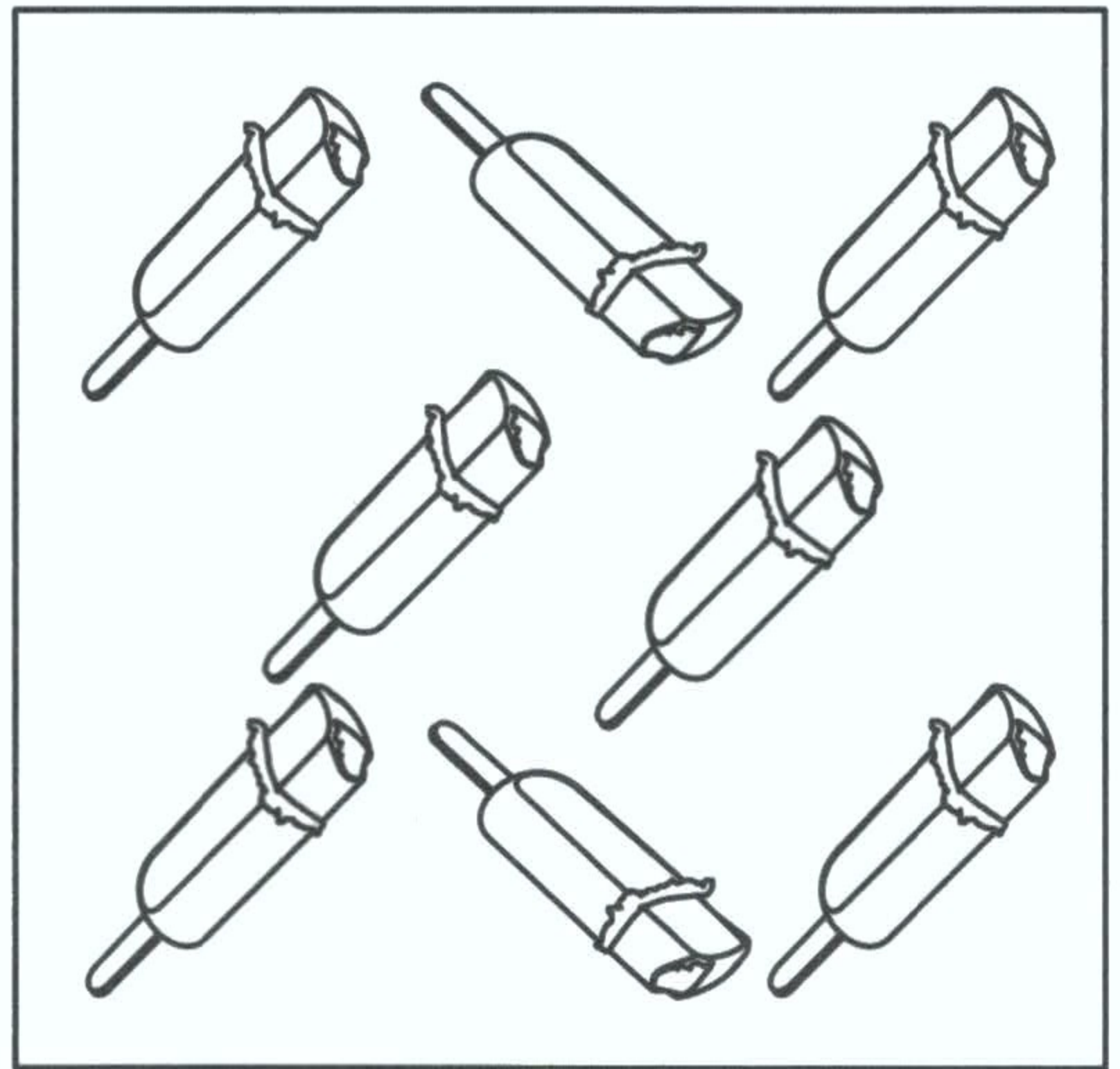
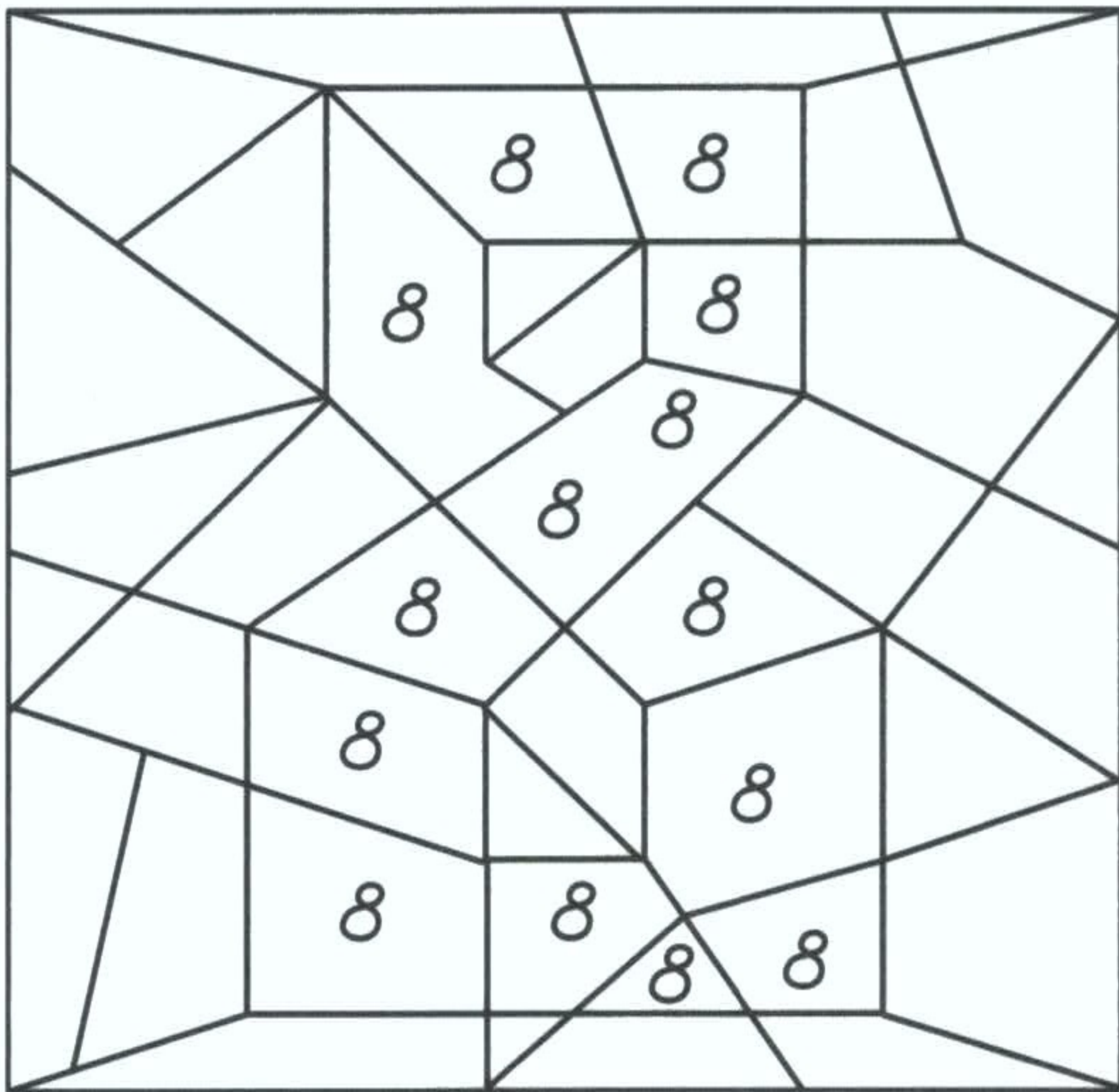
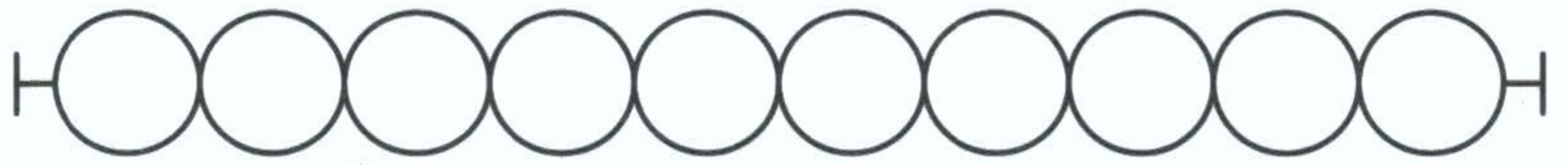
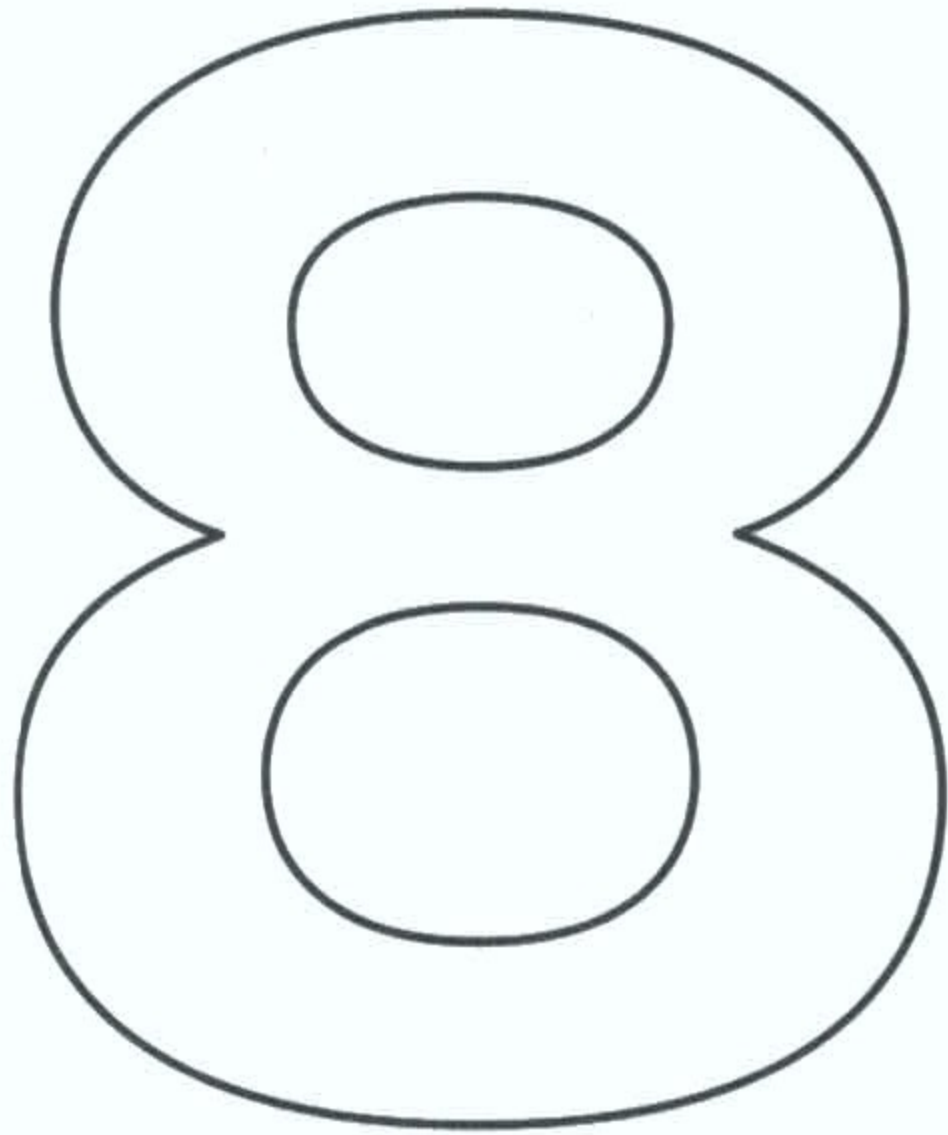

На каждом подносе должно быть по восемь пирожков. Дорисуй на каждом подносе недостающие пирожки.

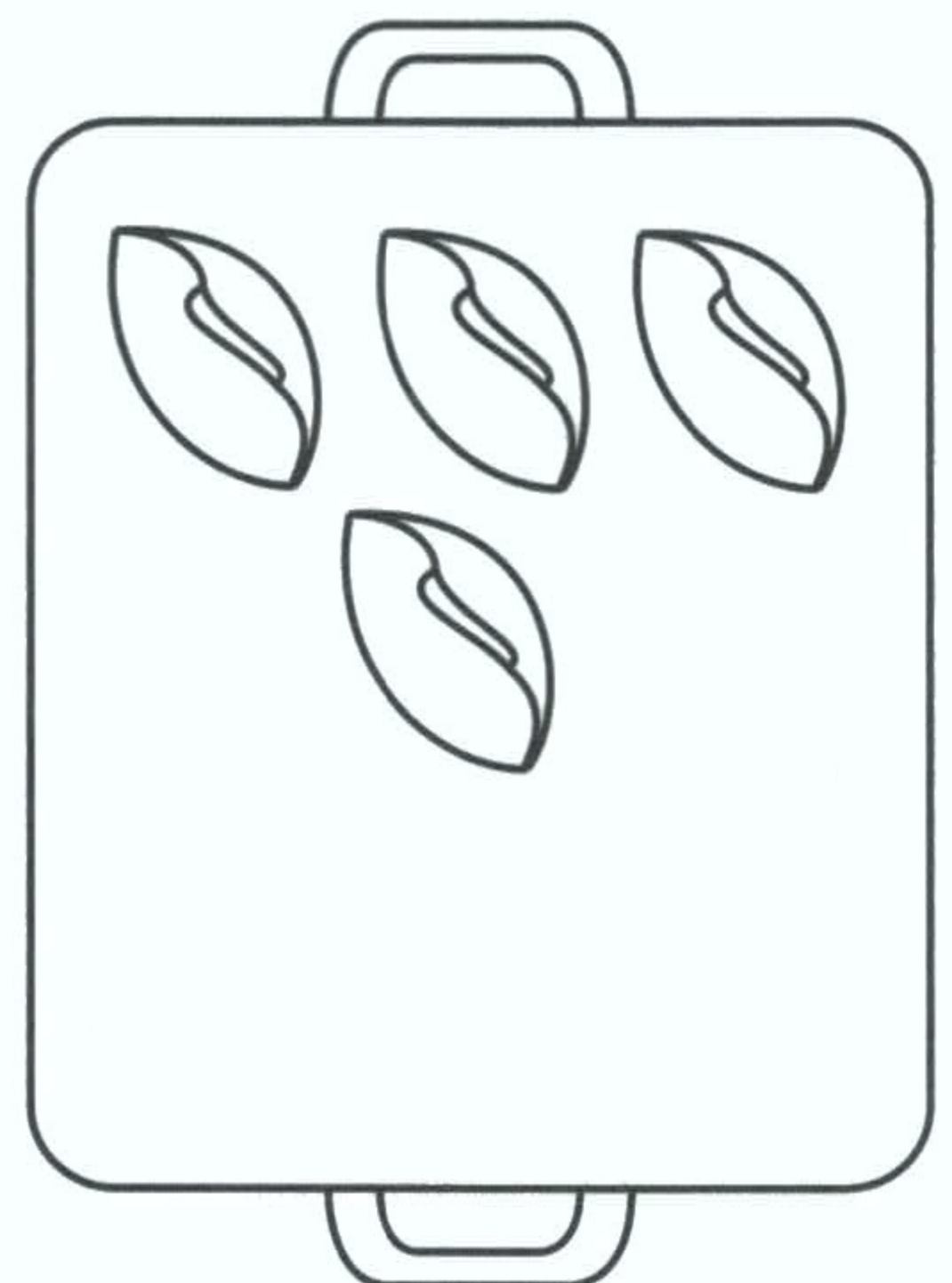
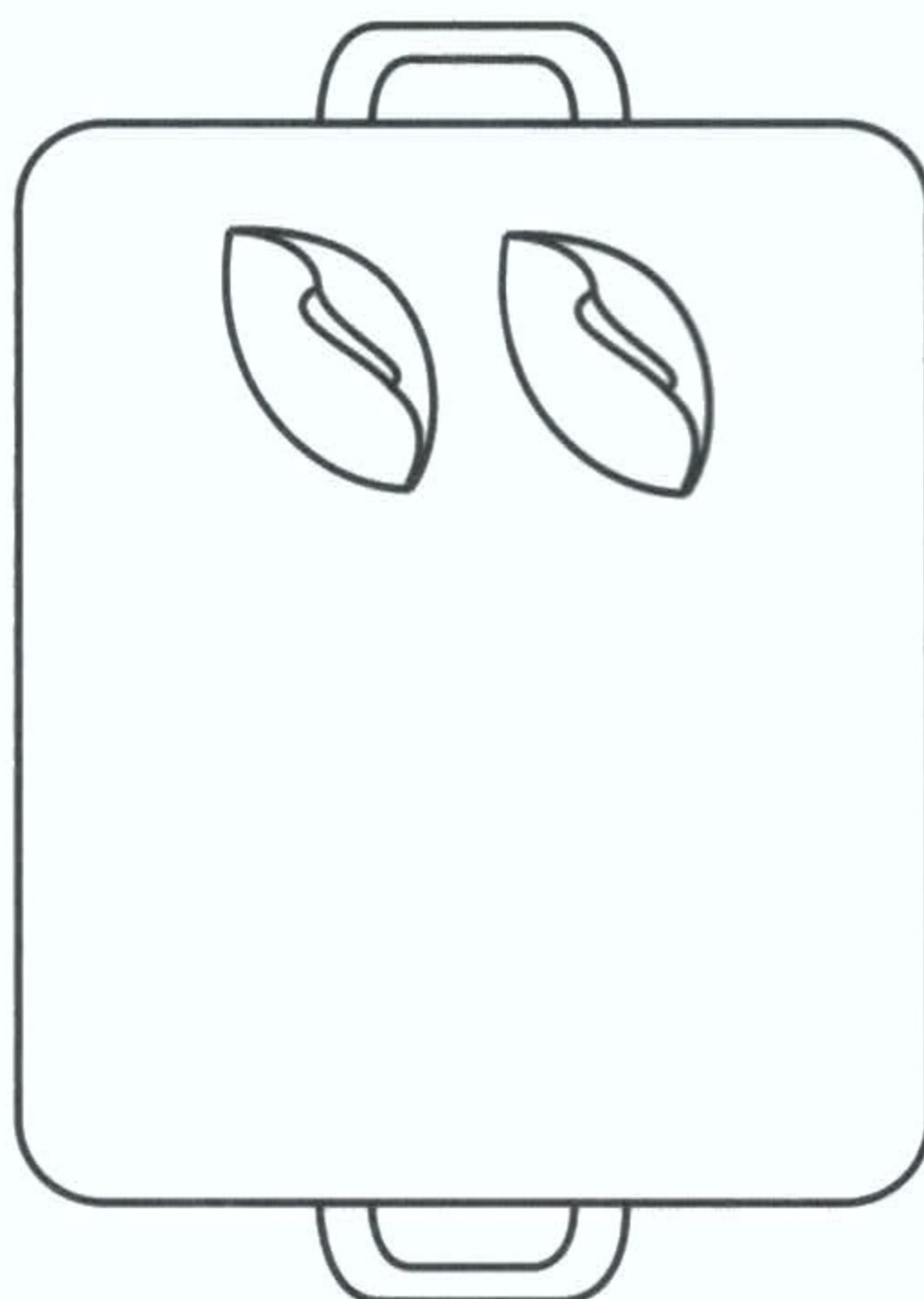
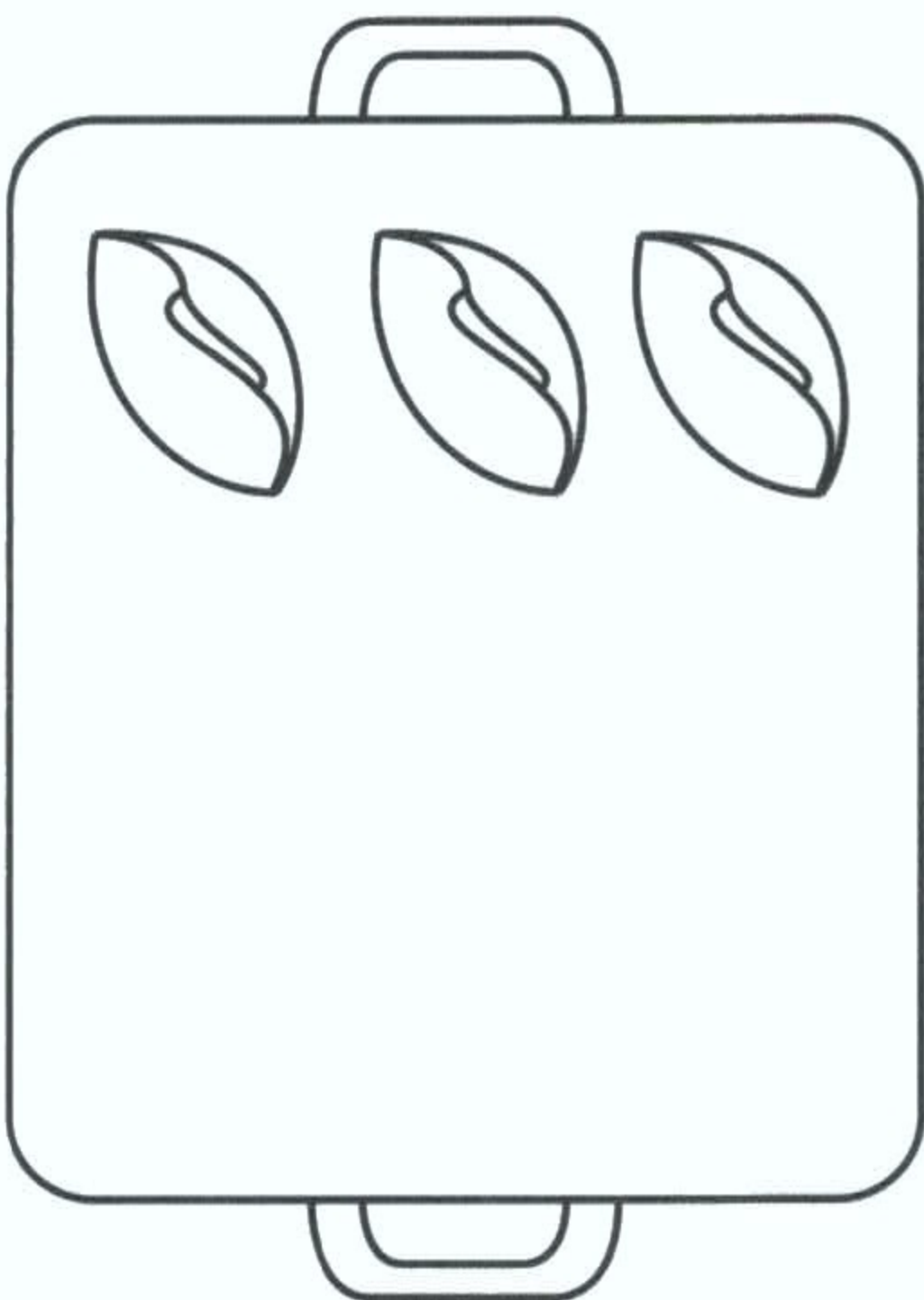

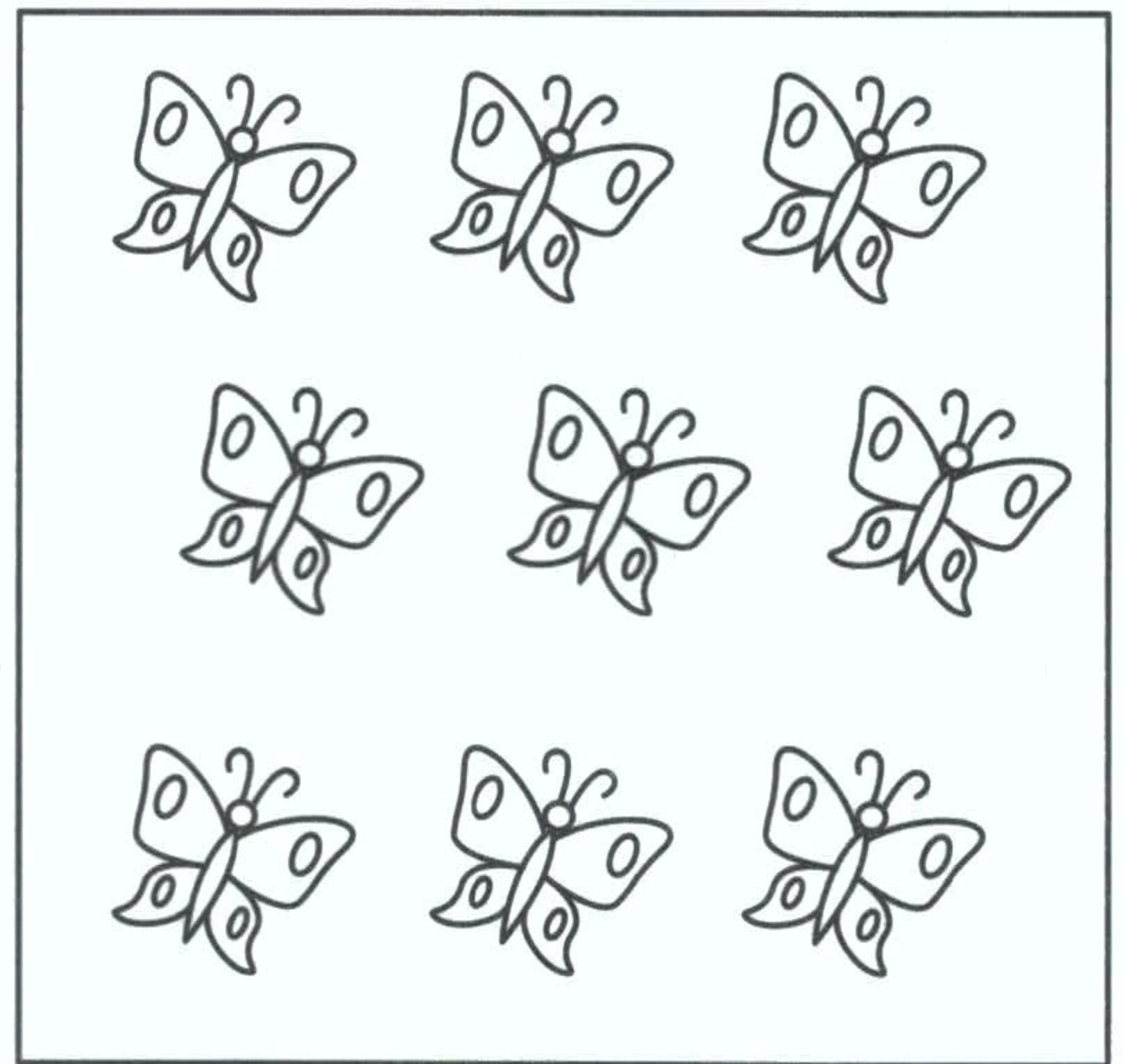
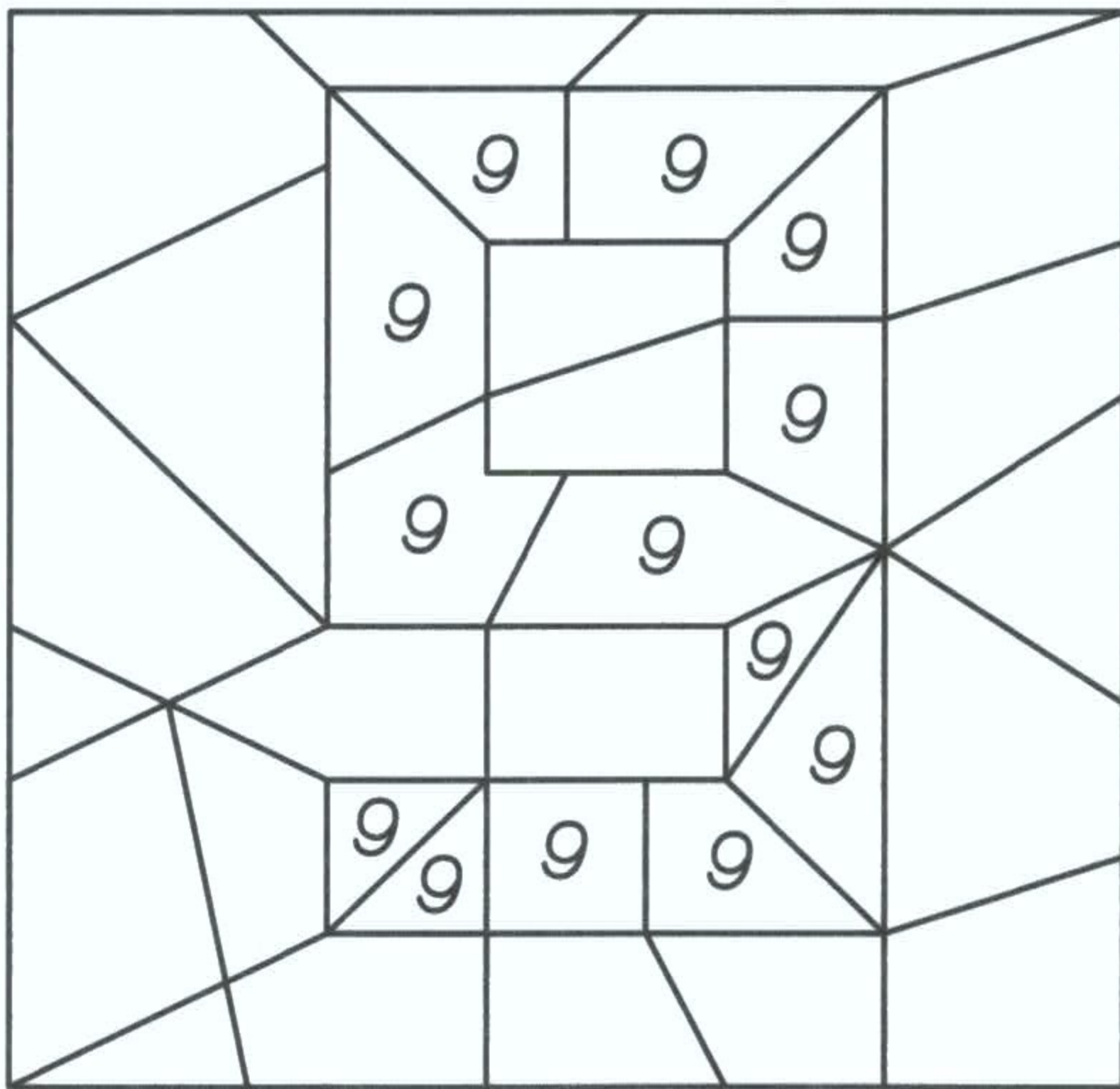
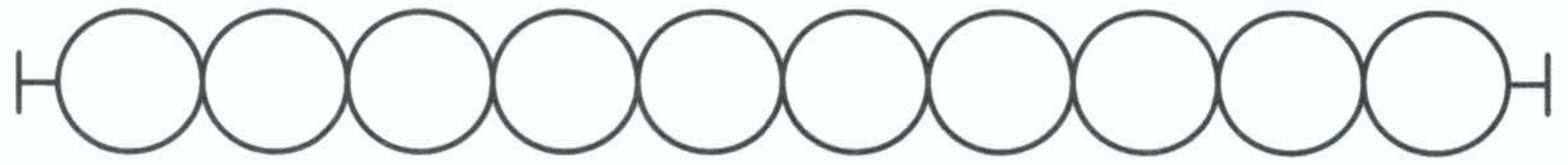
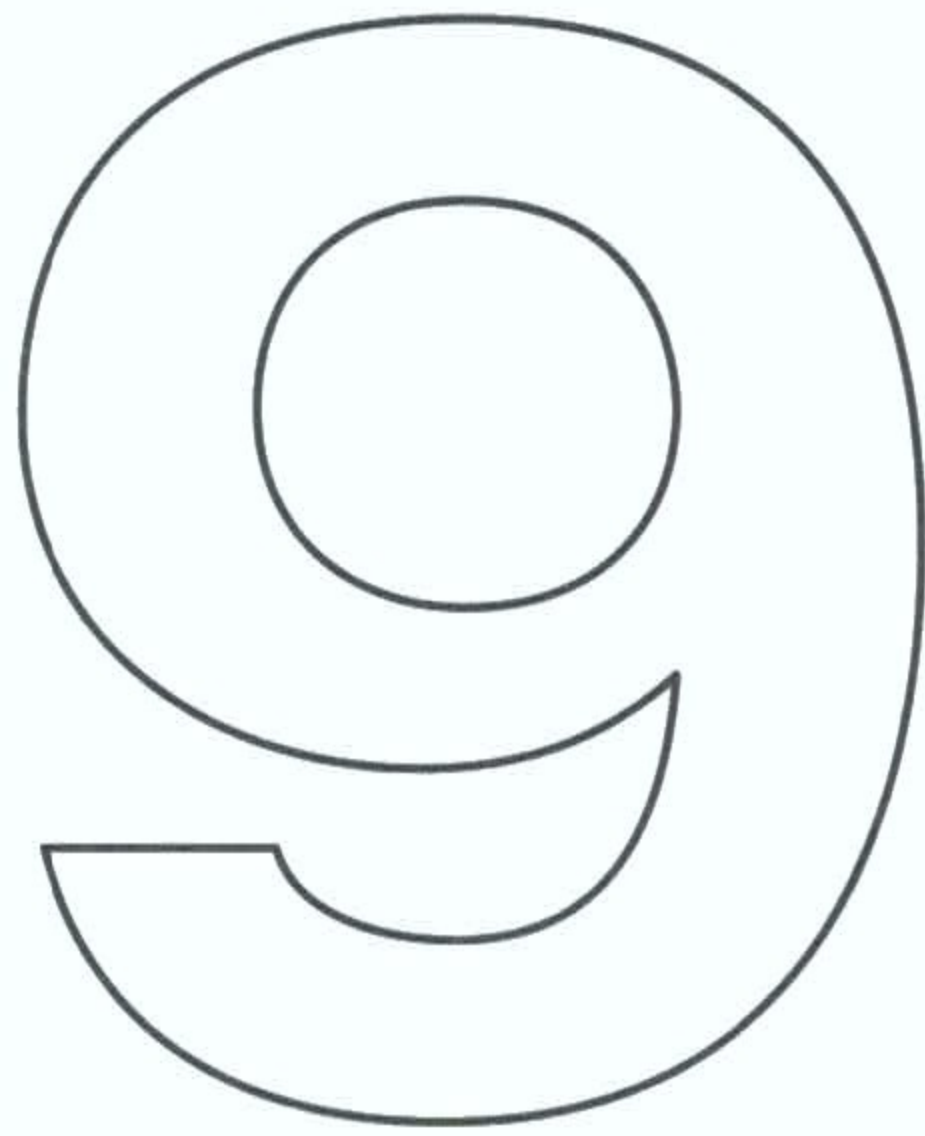

Сосчитай, сколько лепестков у цветка. Соедини с соответствующей цифрой.

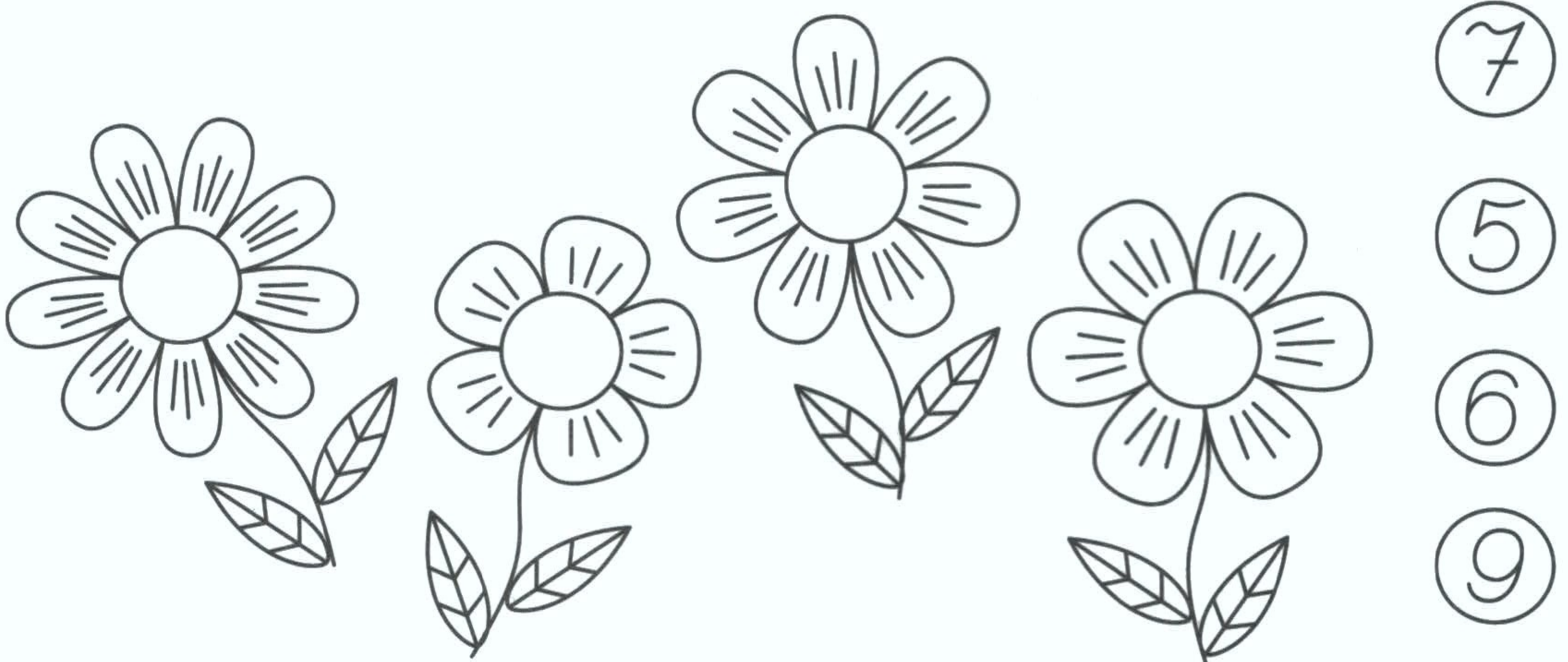

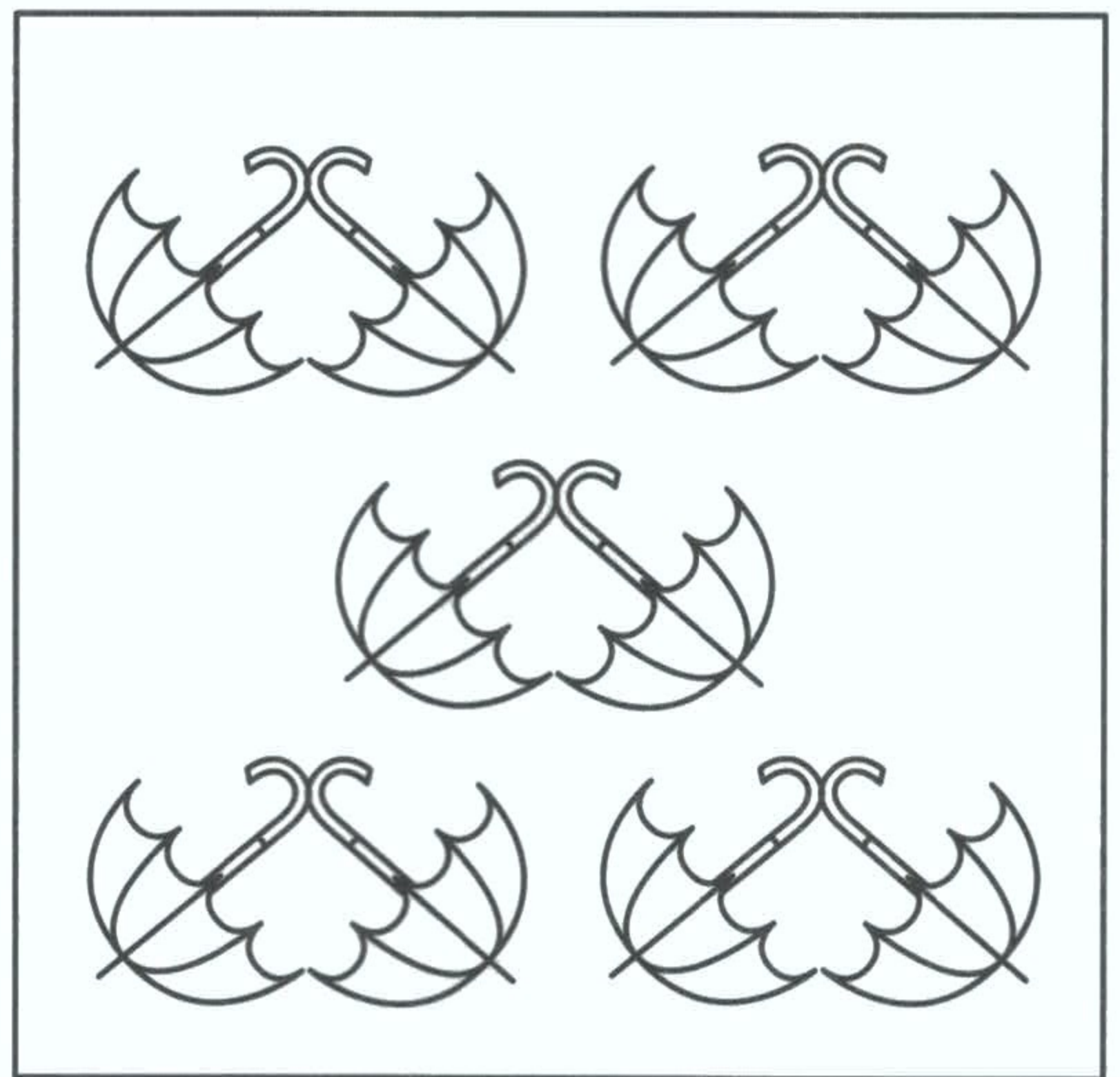
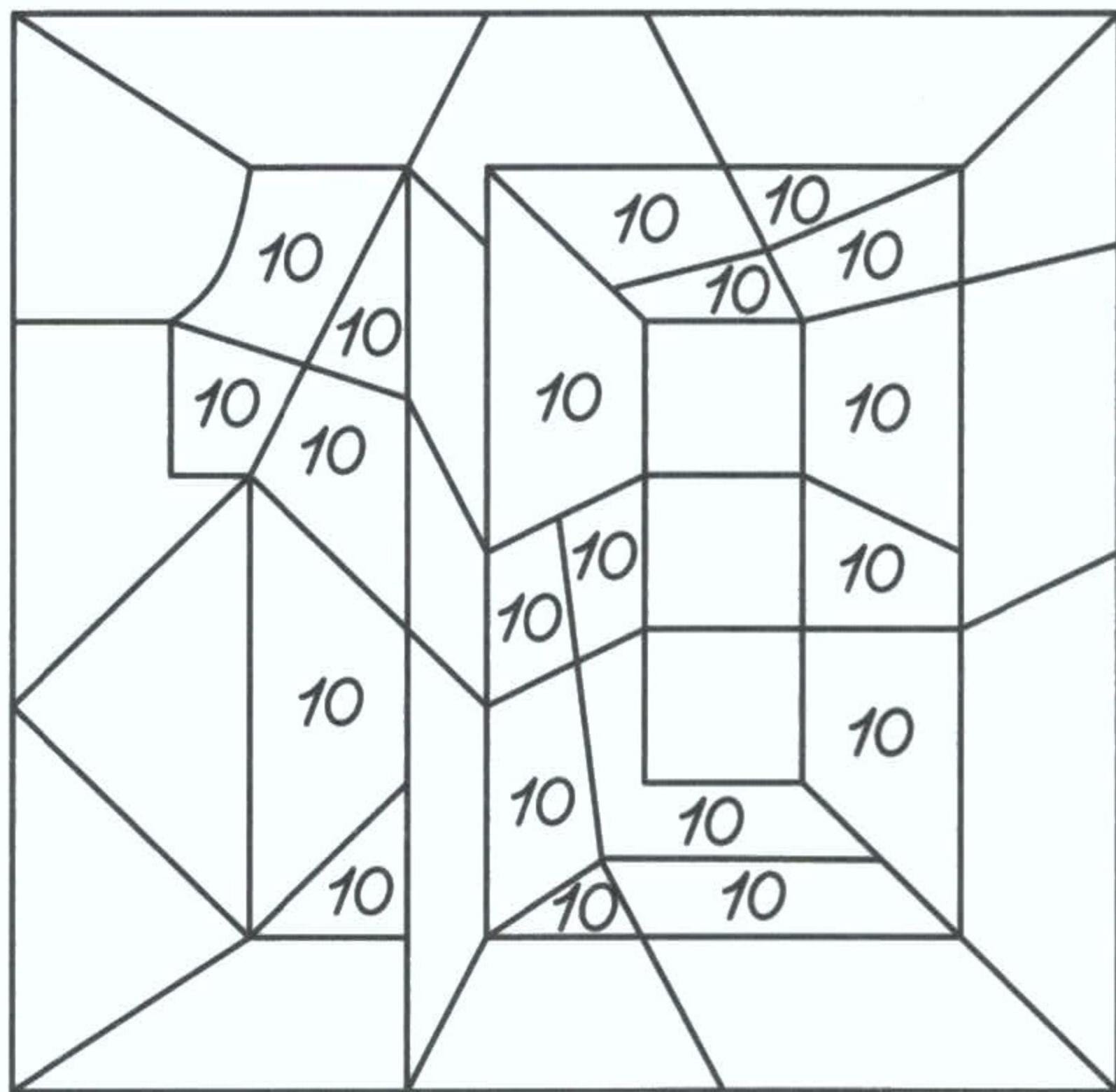
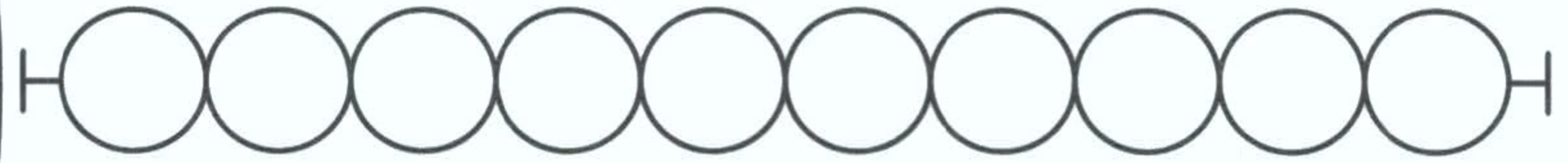

Сосчитай, сколько пуговиц нарисовано. Раскрась так, чтобы зелёных пуговиц было больше, чем жёлтых.

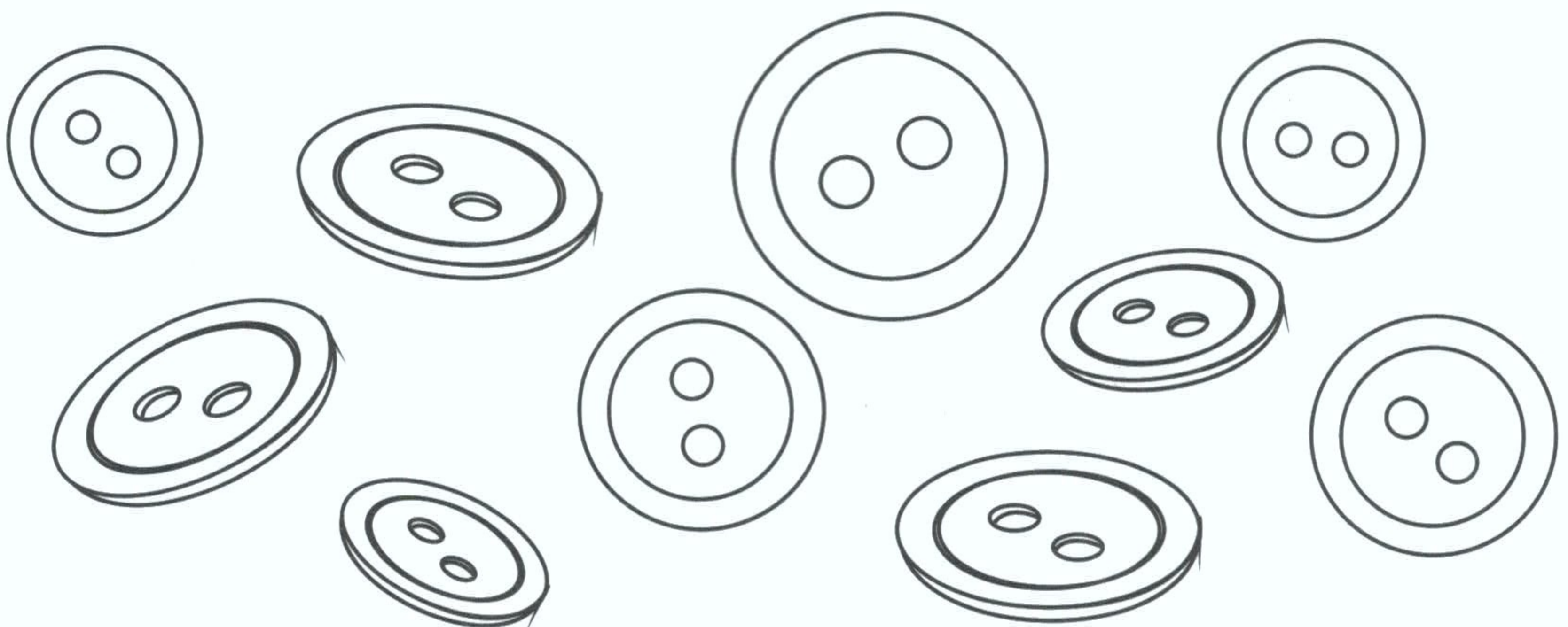

Соедини нужную цифру с соответствующей картинкой.

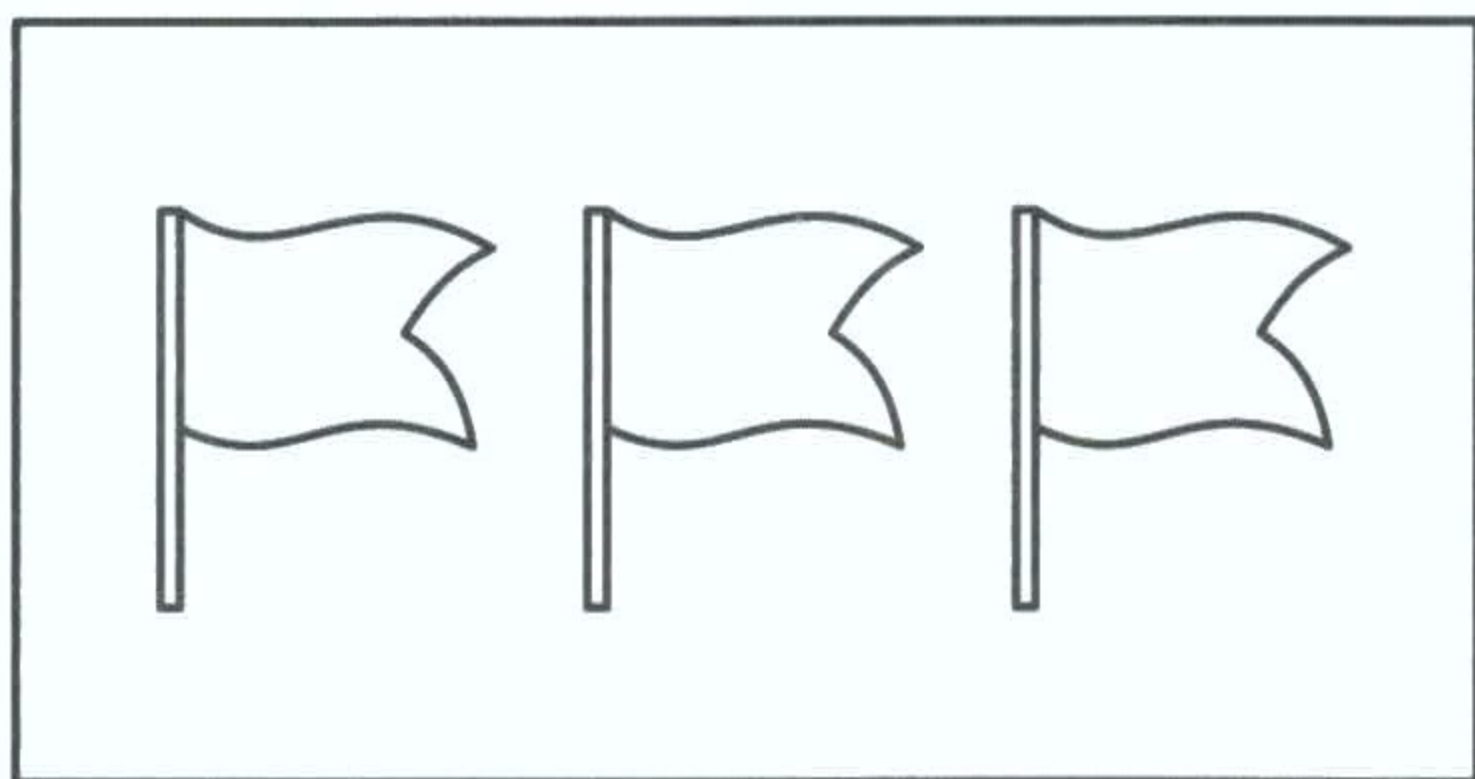

1

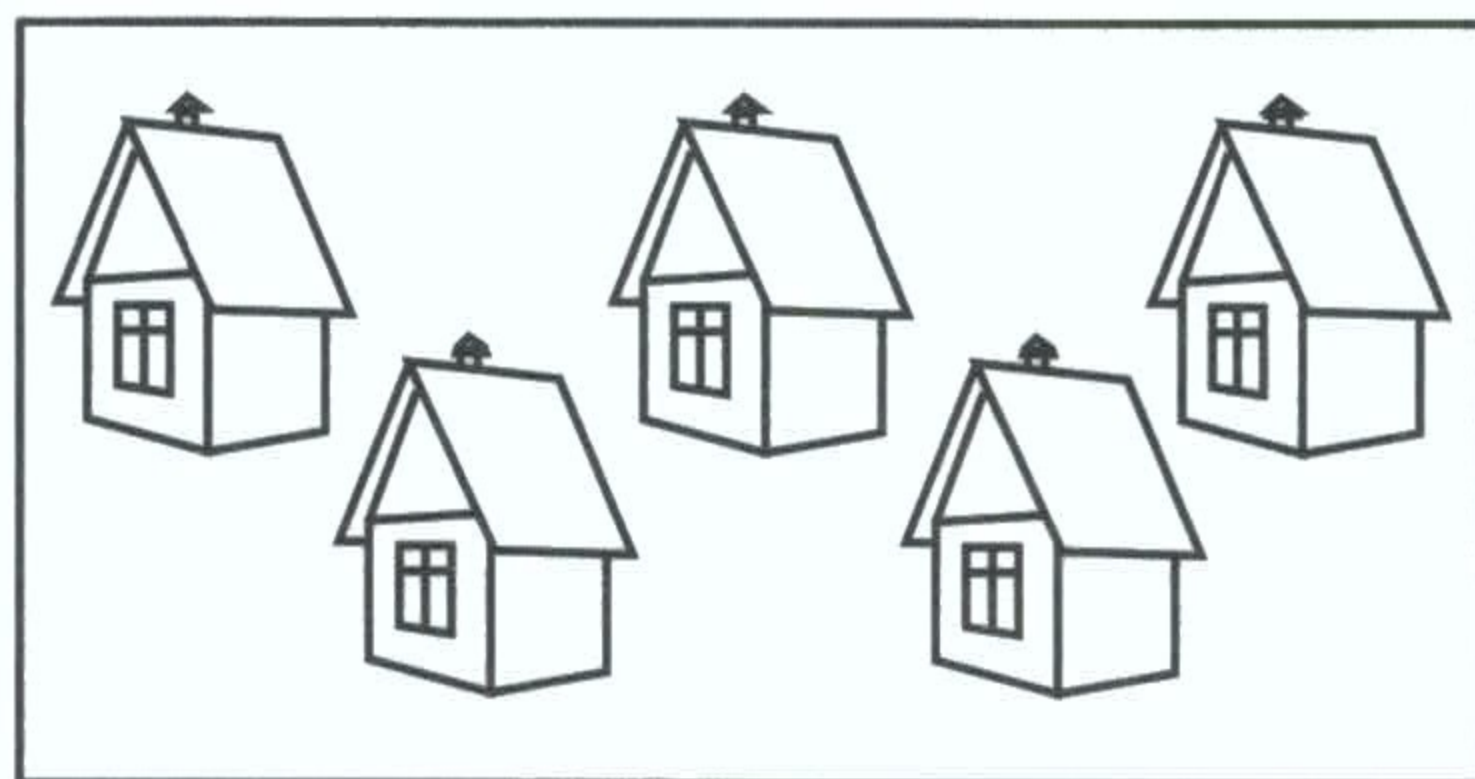

2

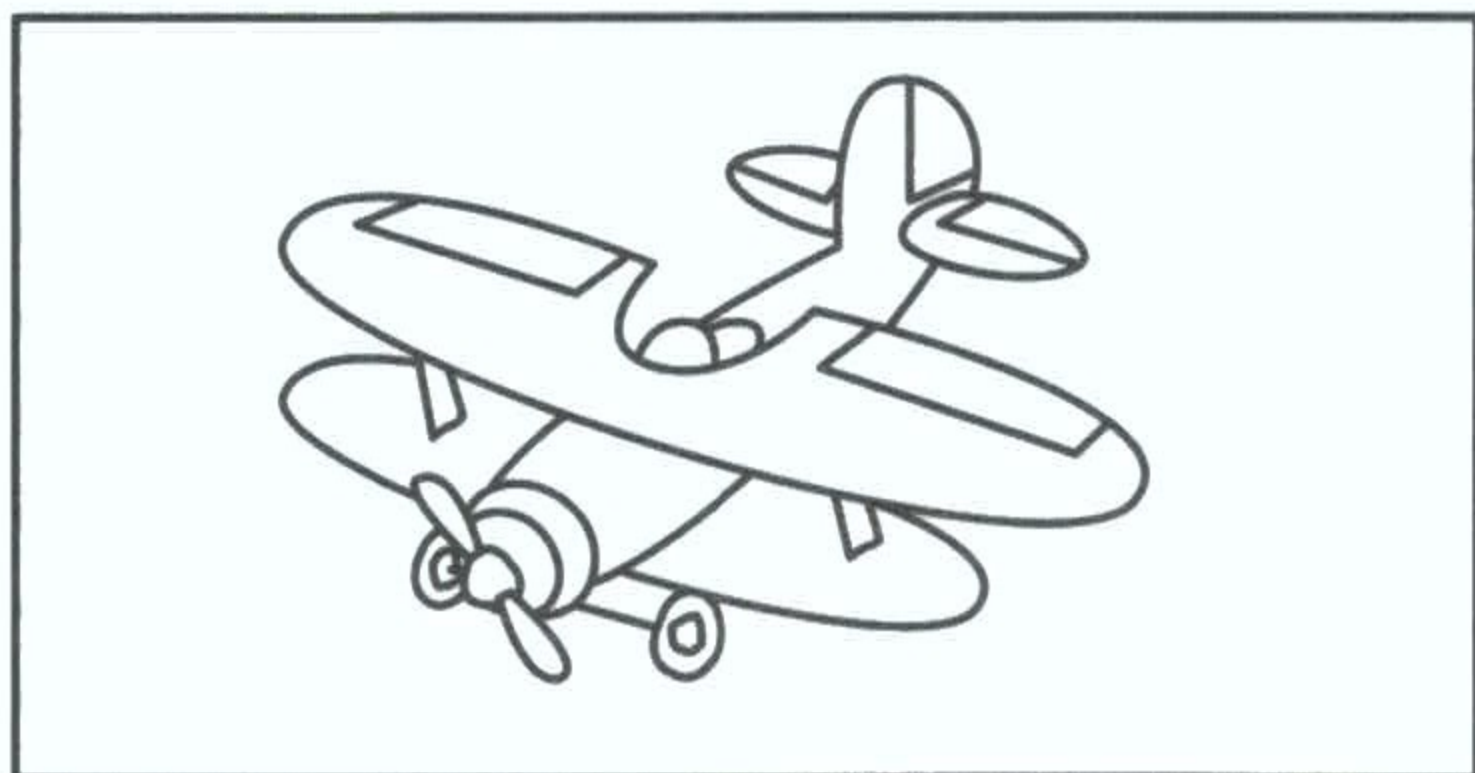

3

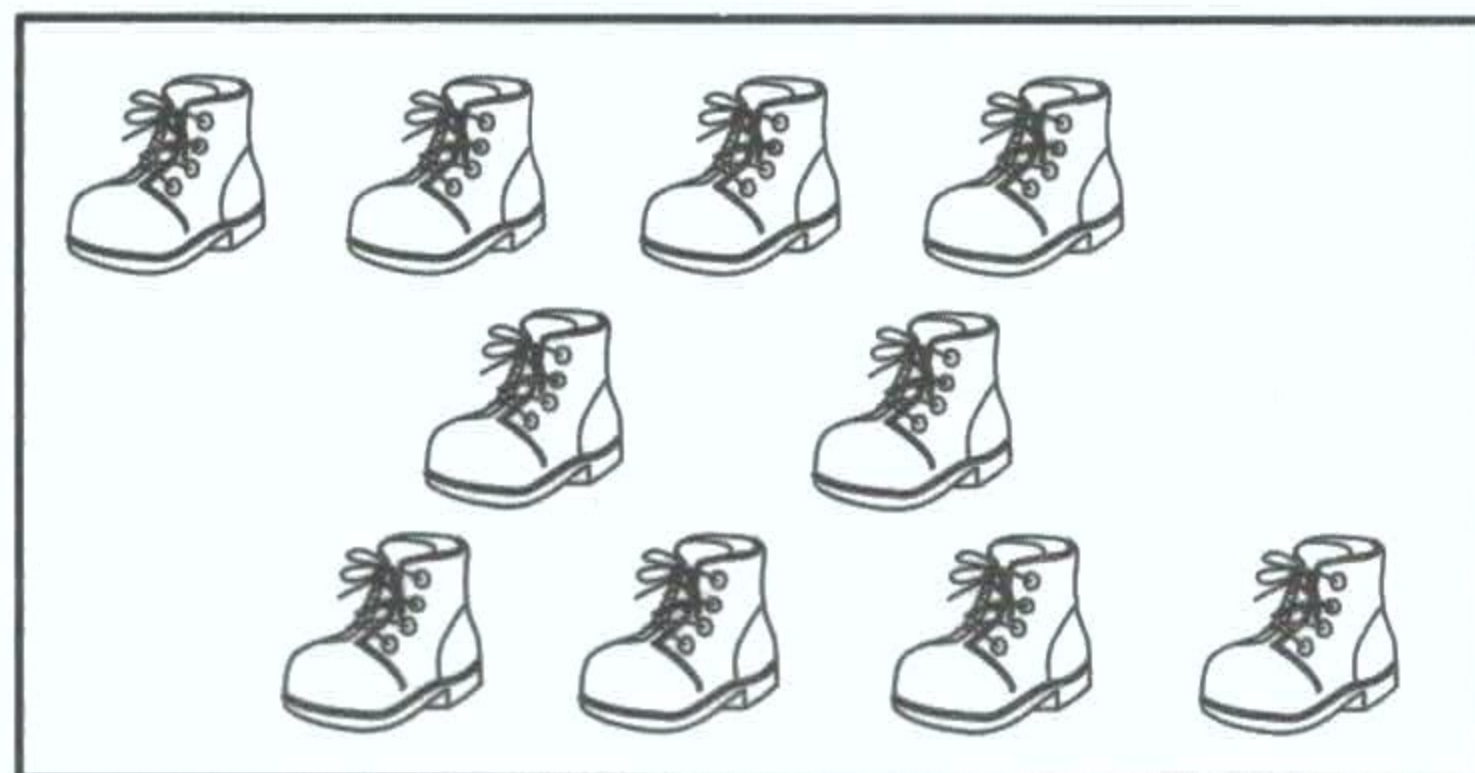

4

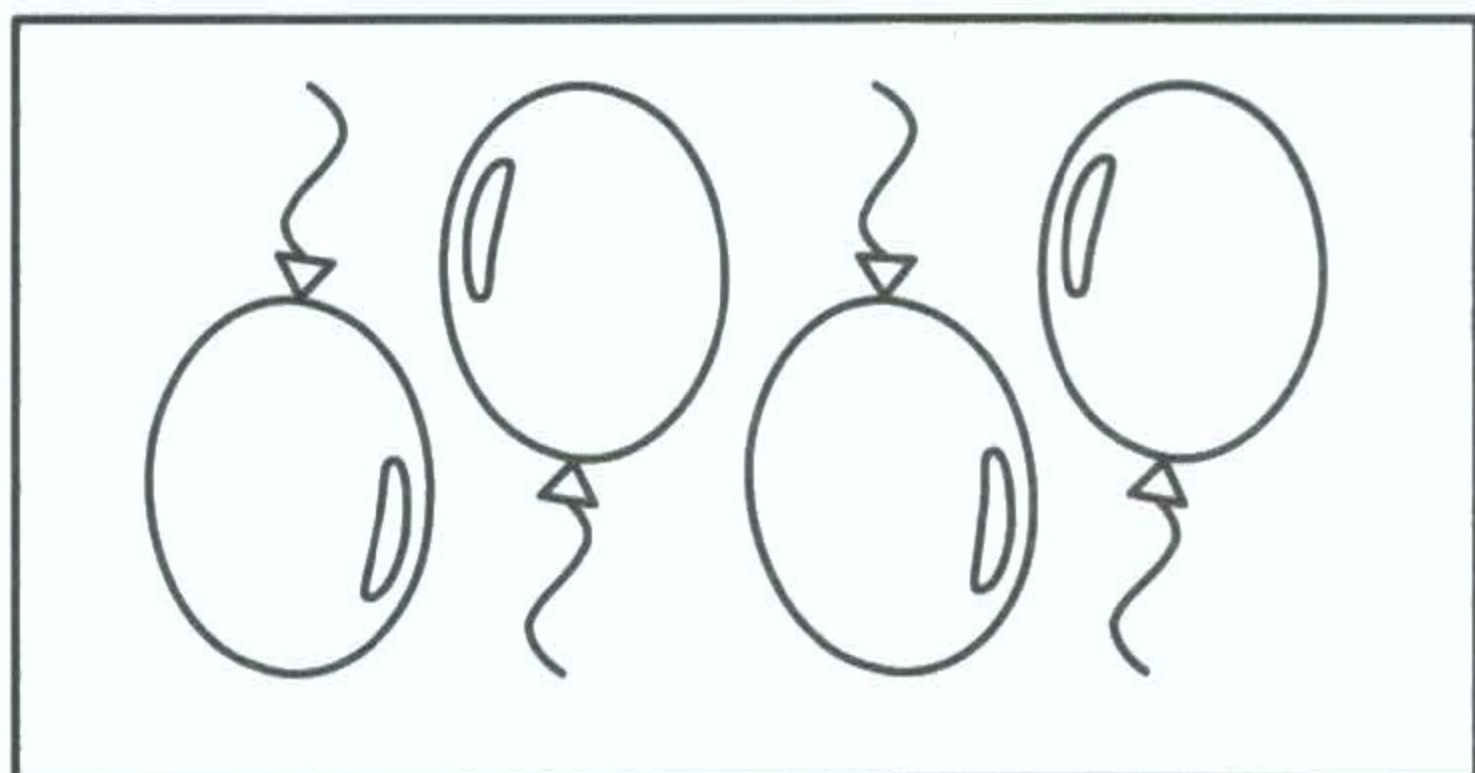

5

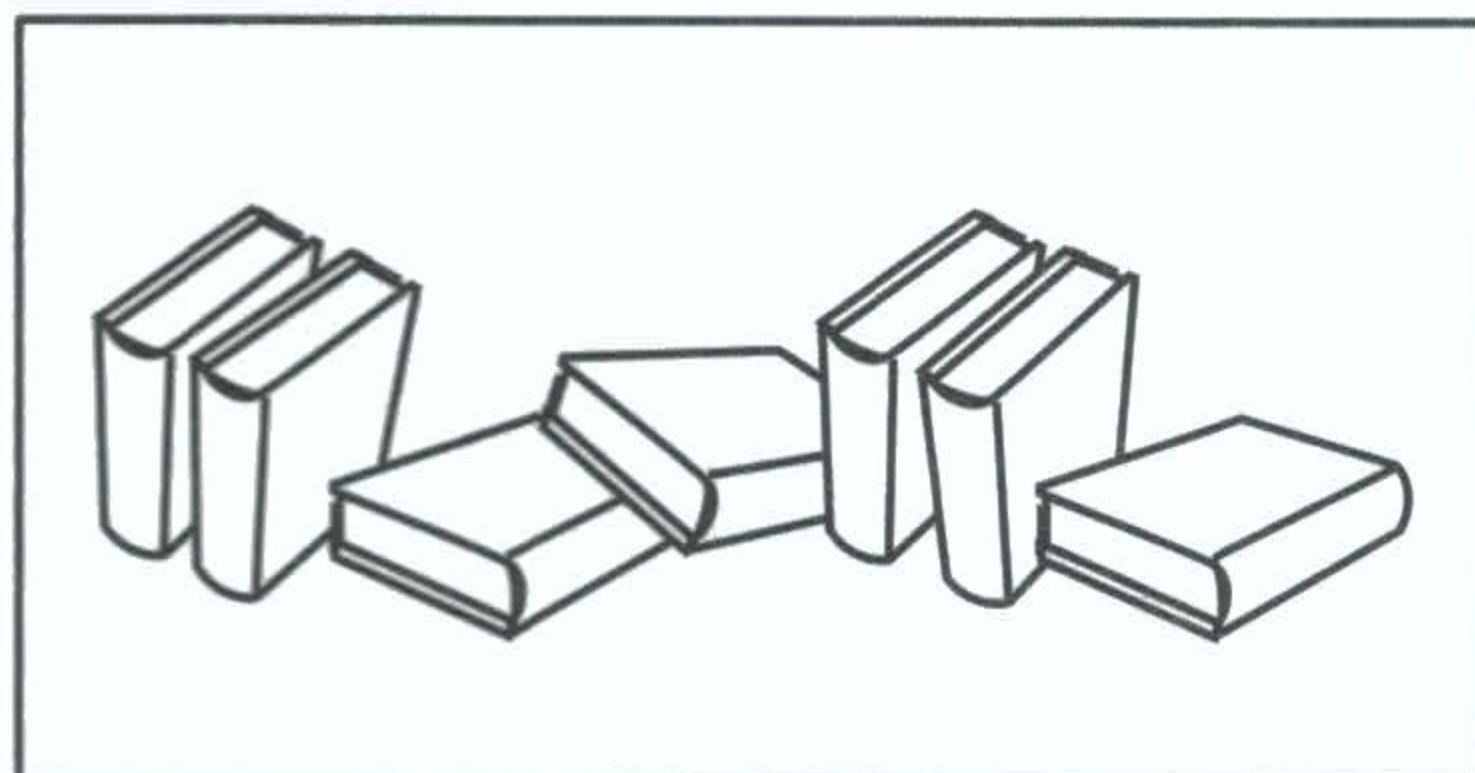

6

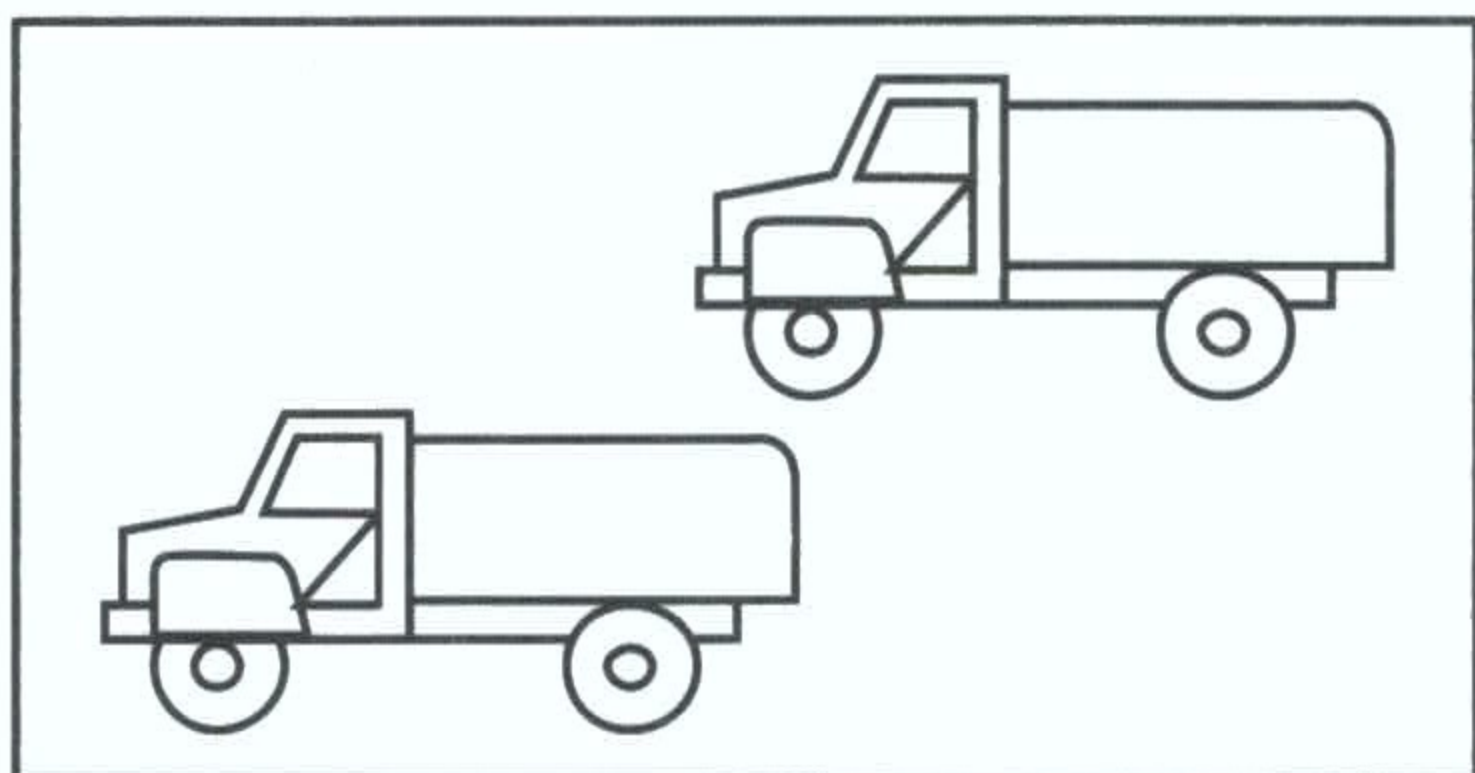

7

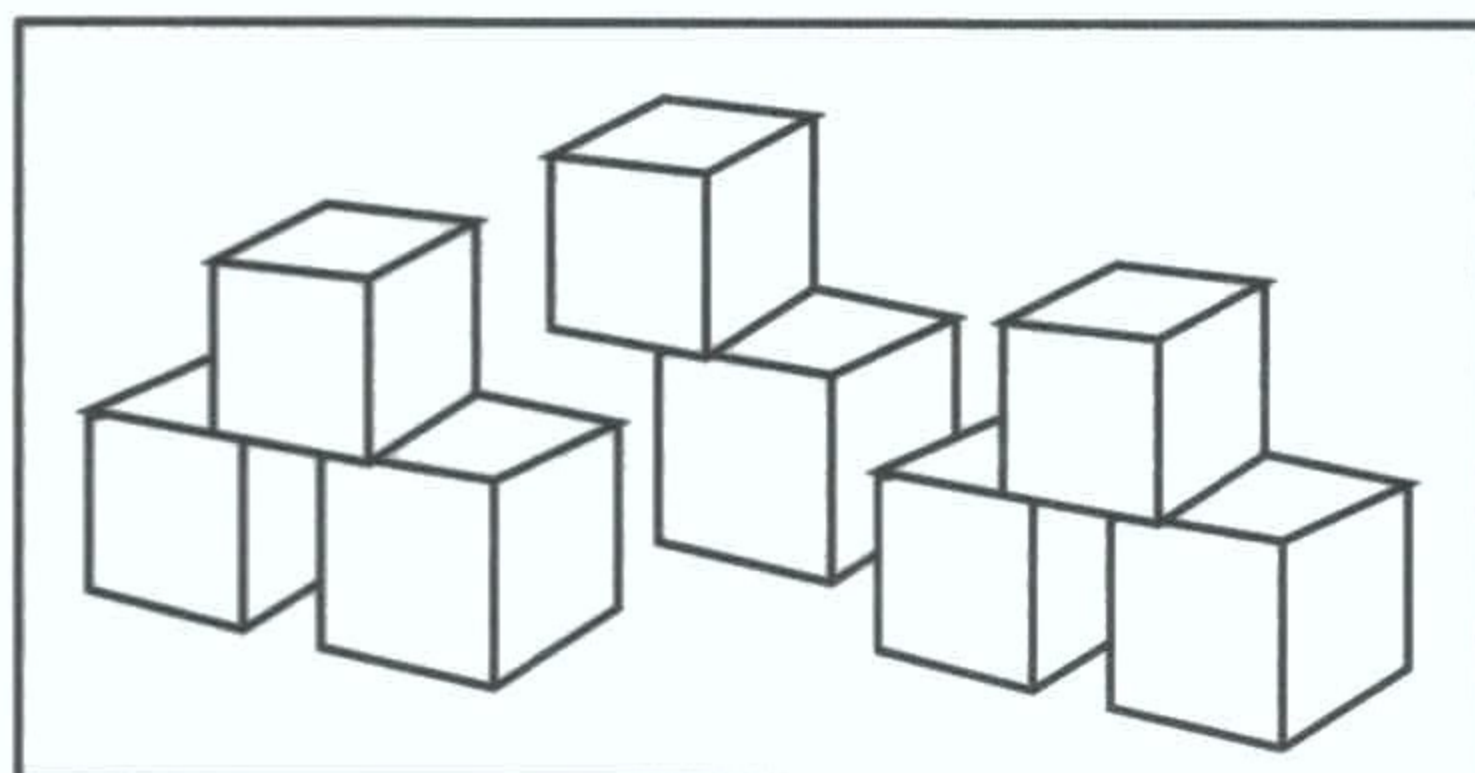

8

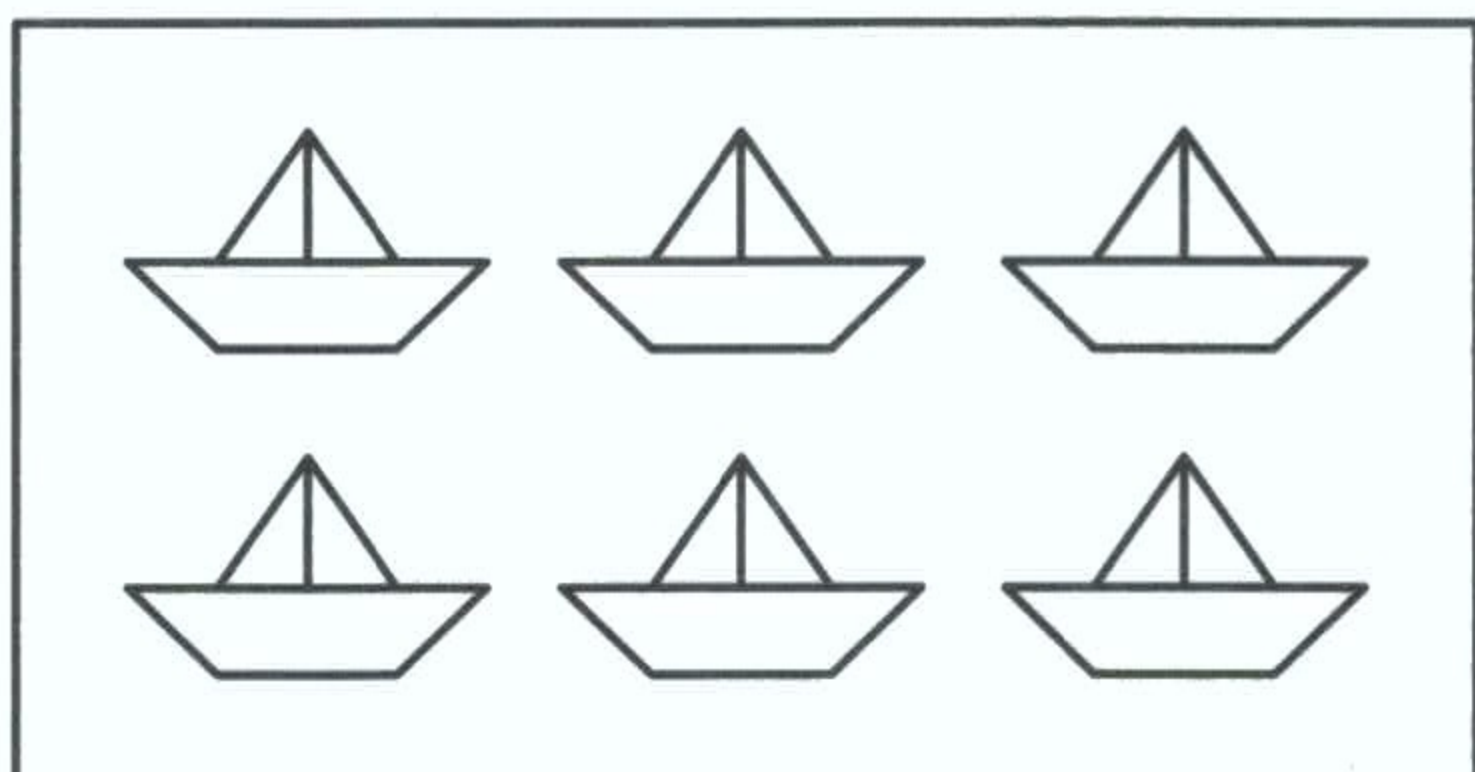

9

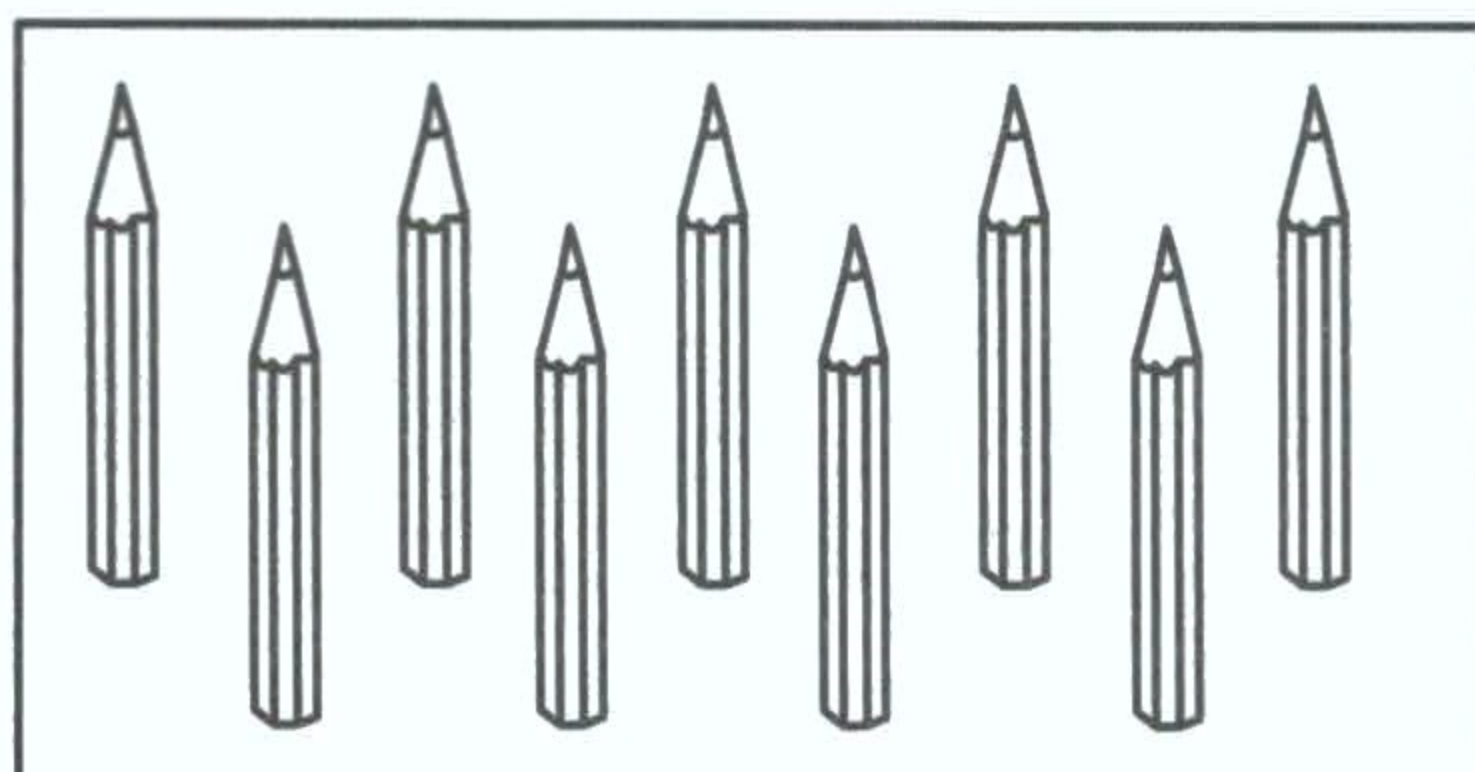





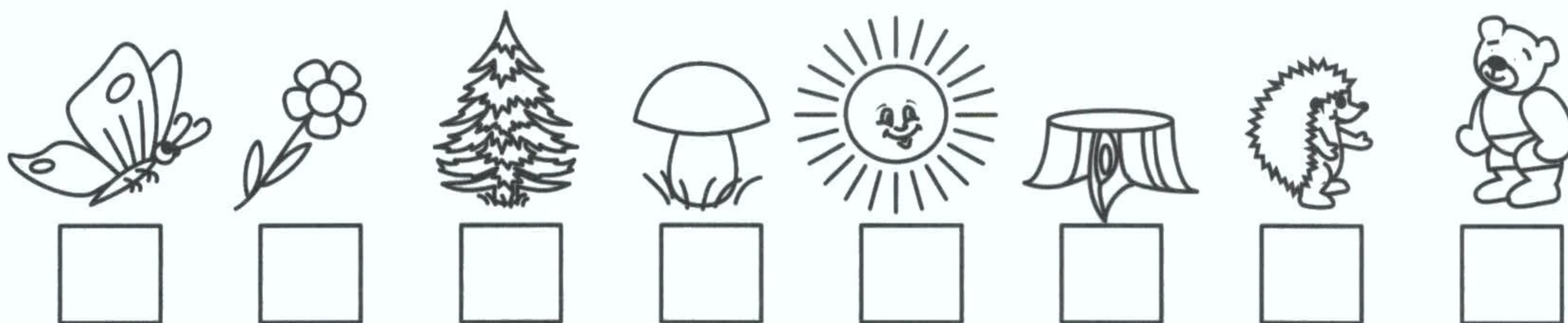



10

По сколько на рисунке разных предметов? Напиши в клетках нужную цифру. Какие цифры ты не написал?



Раскрась в каждом ряду столько предметов, сколько указано цифрой.

1	
2	
3	
4	
5	
6	
7	
8	

Вставь пропущенные цифры.

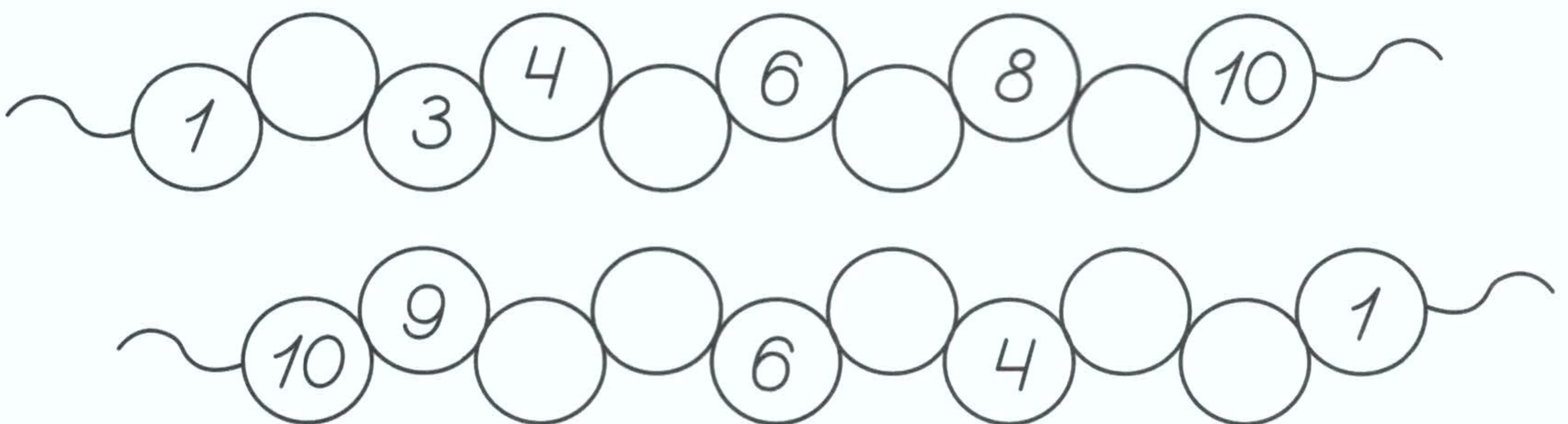

Найди ошибки. Дорисуй нужное количество точек.

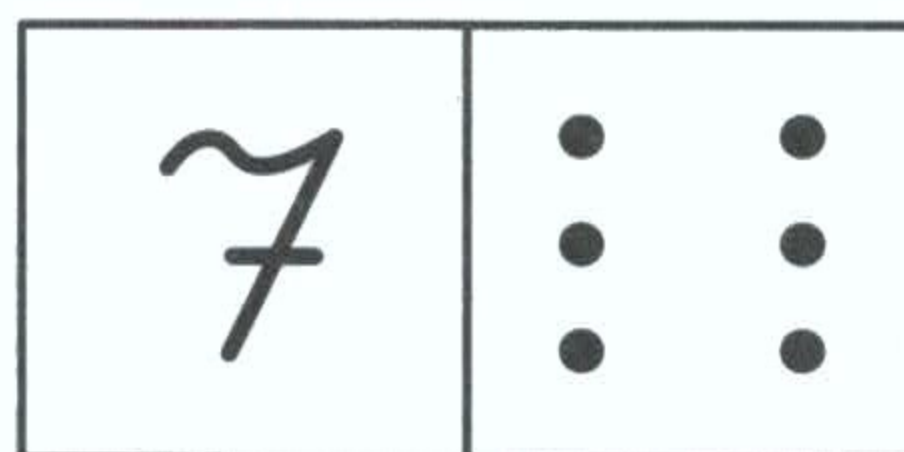
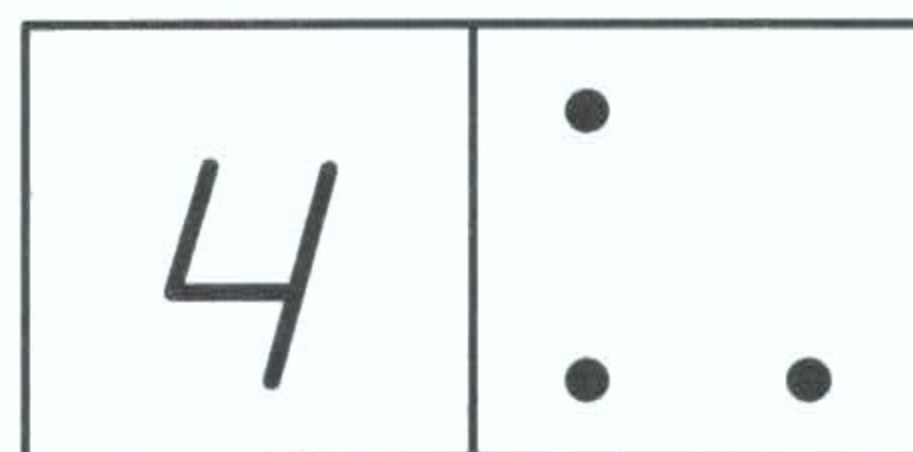
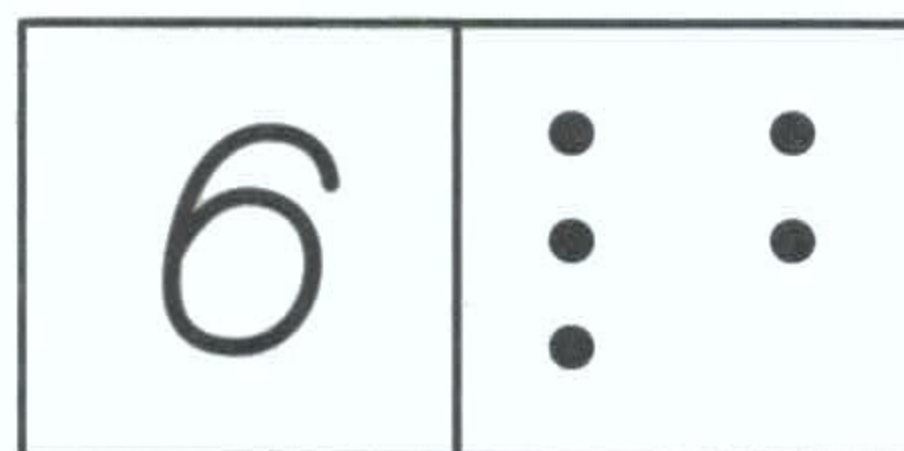
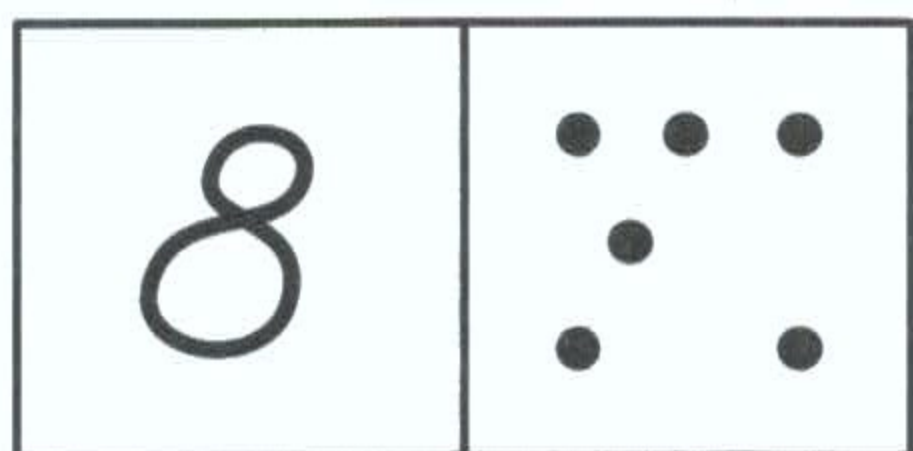
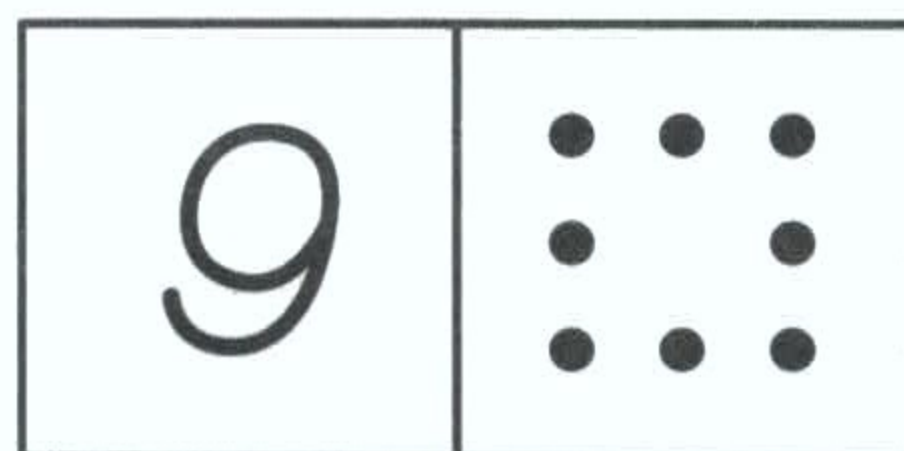
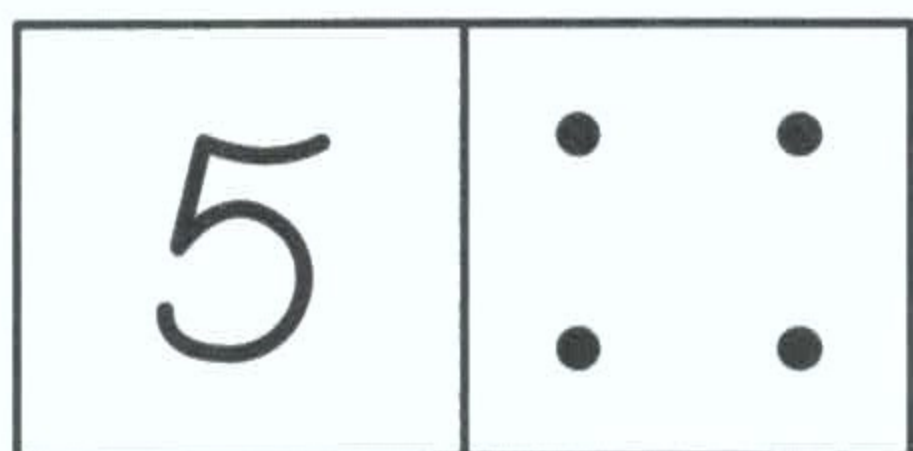

Сосчитай, сколько точек на спине у божьей коровки. Напиши цифру.

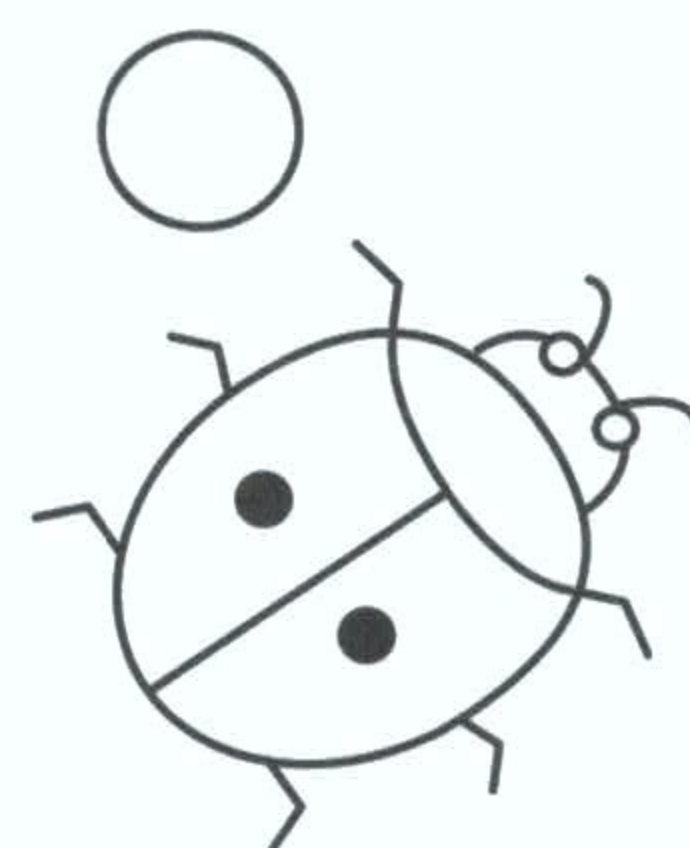
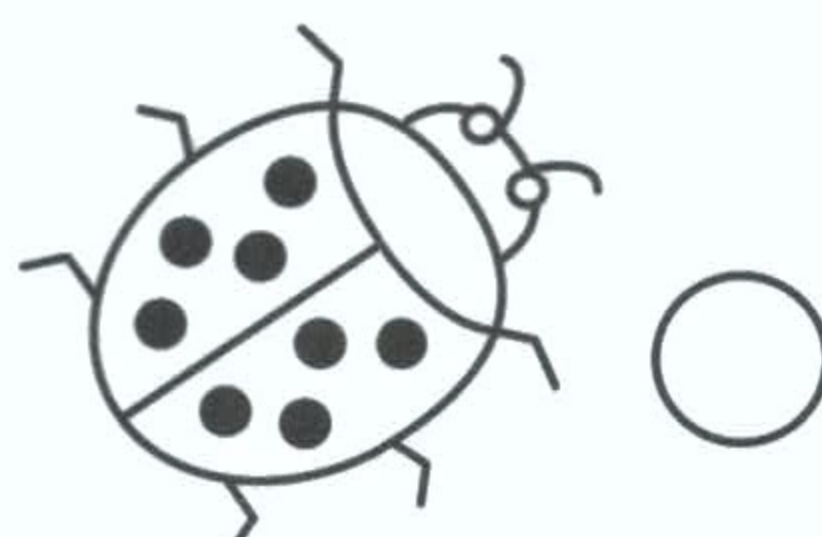
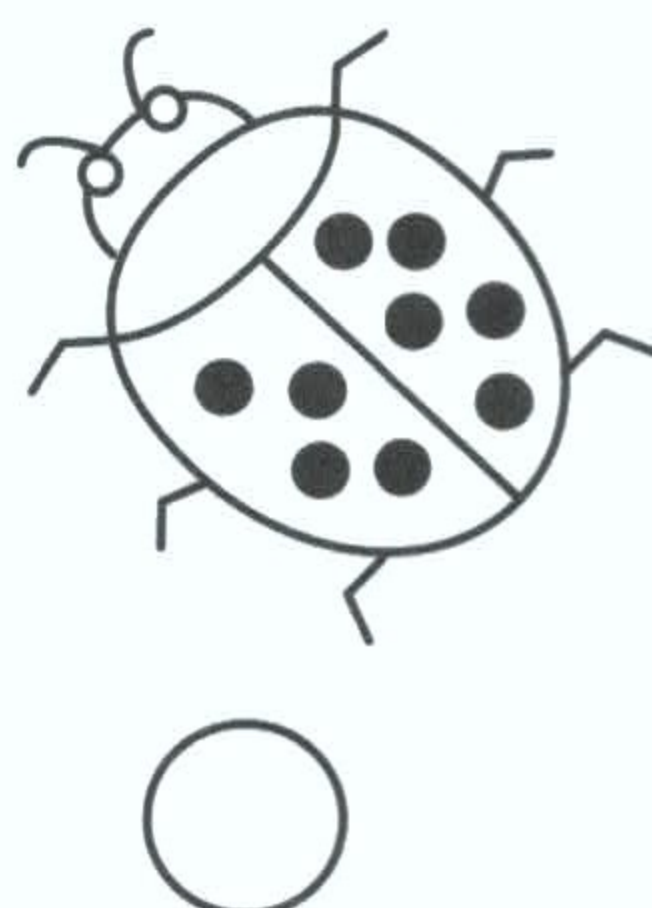
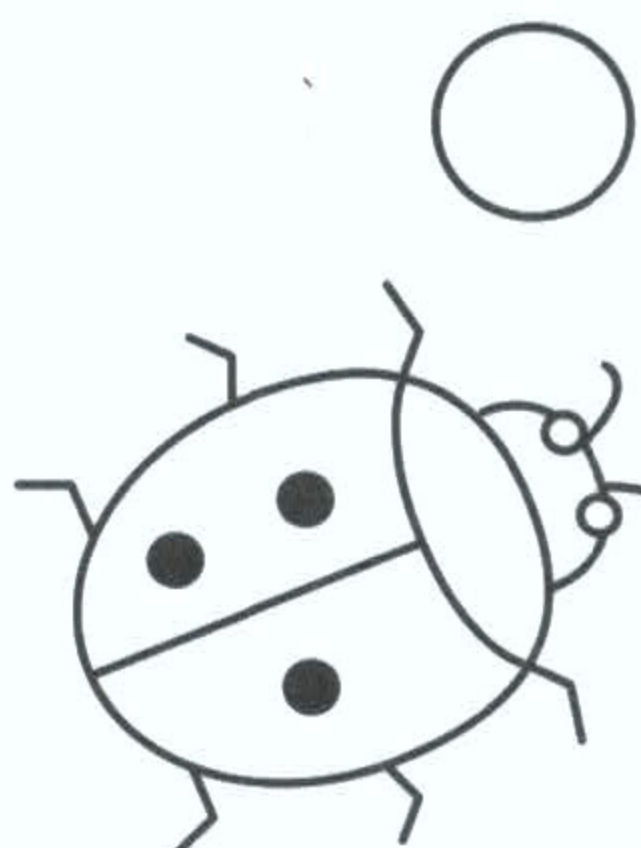
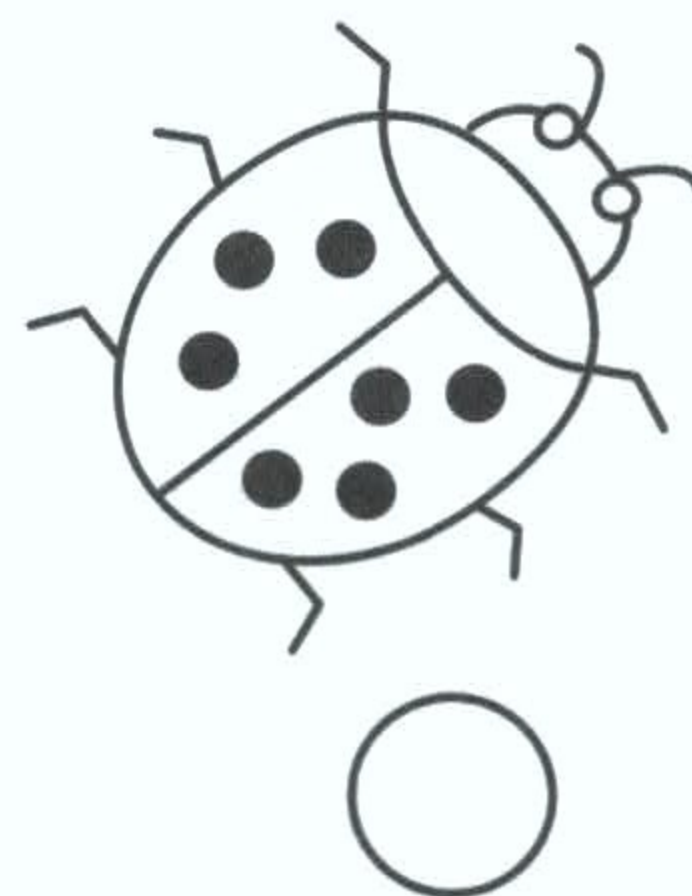
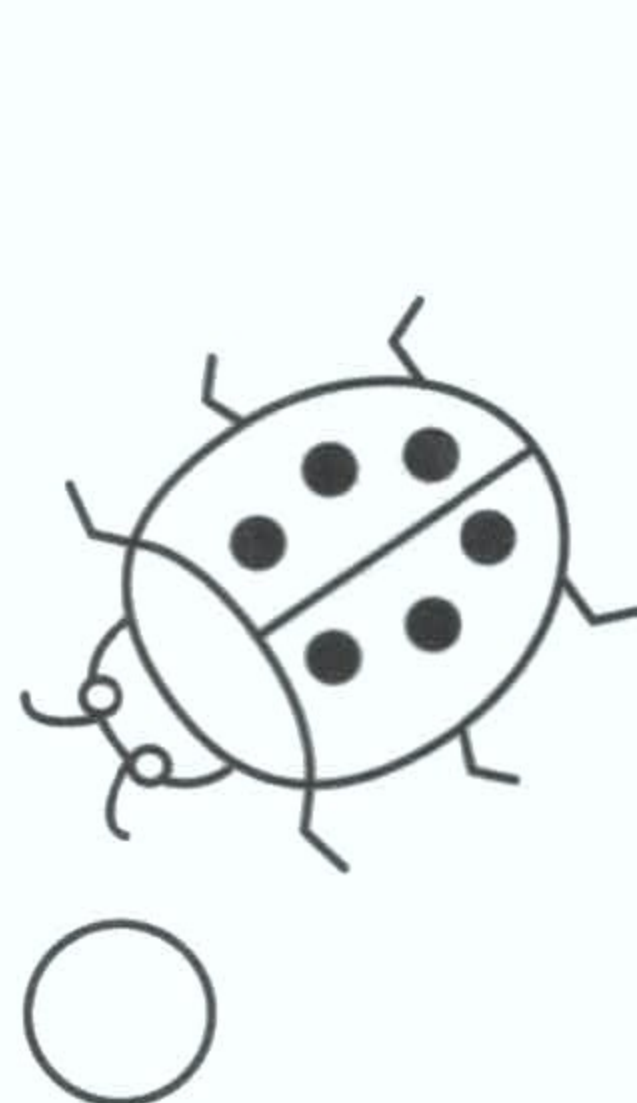
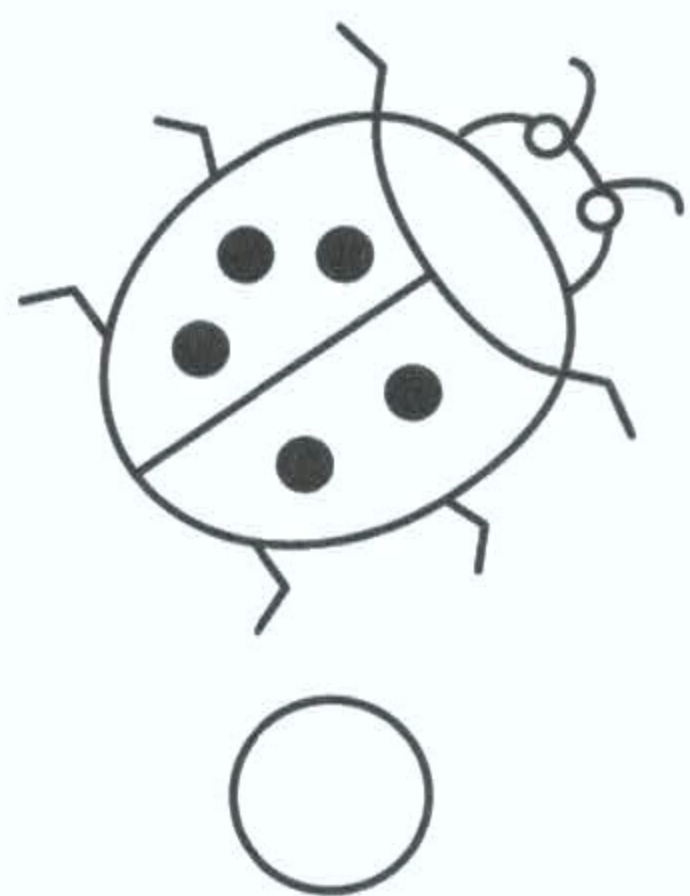

Соедини овалы с одинаковым количеством предметов.

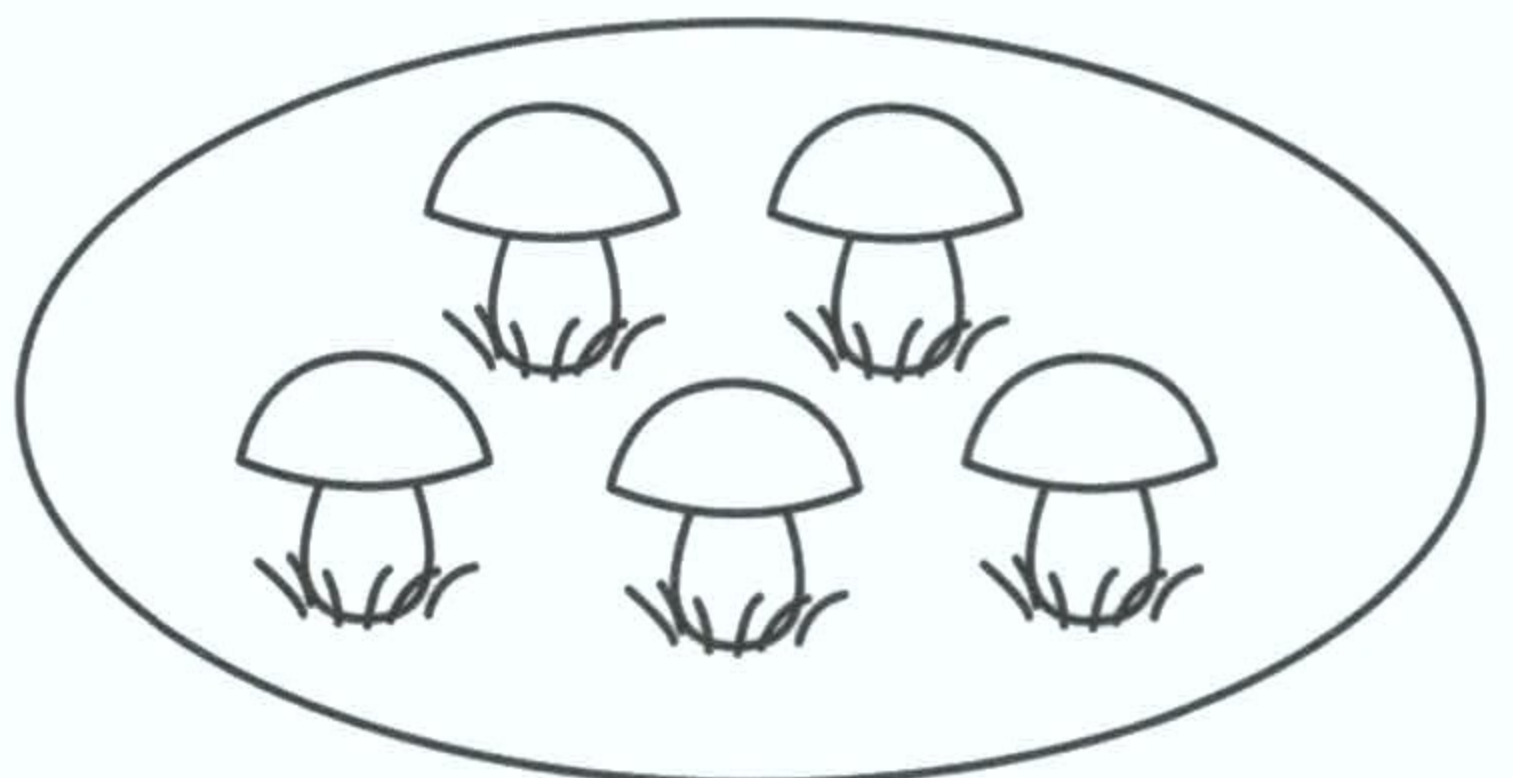
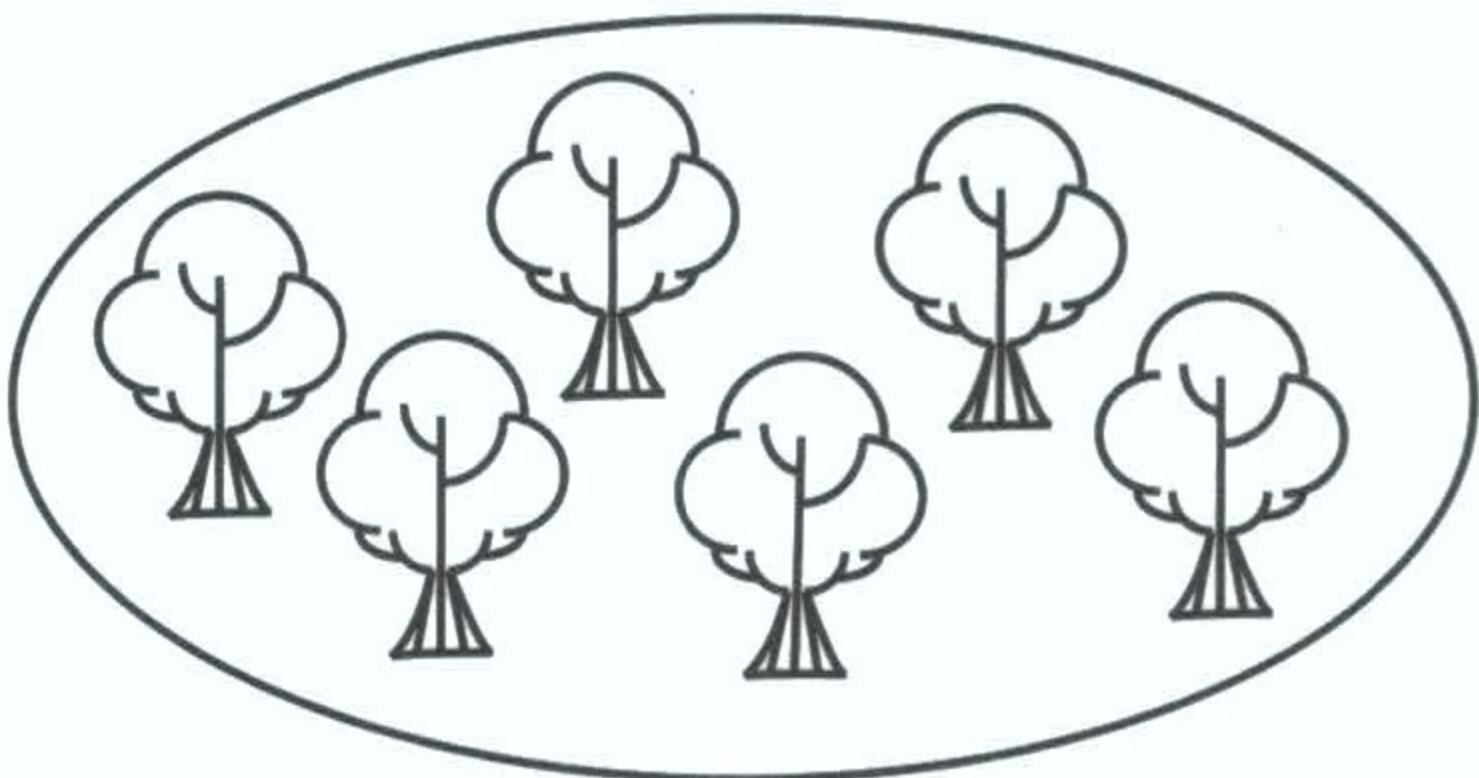
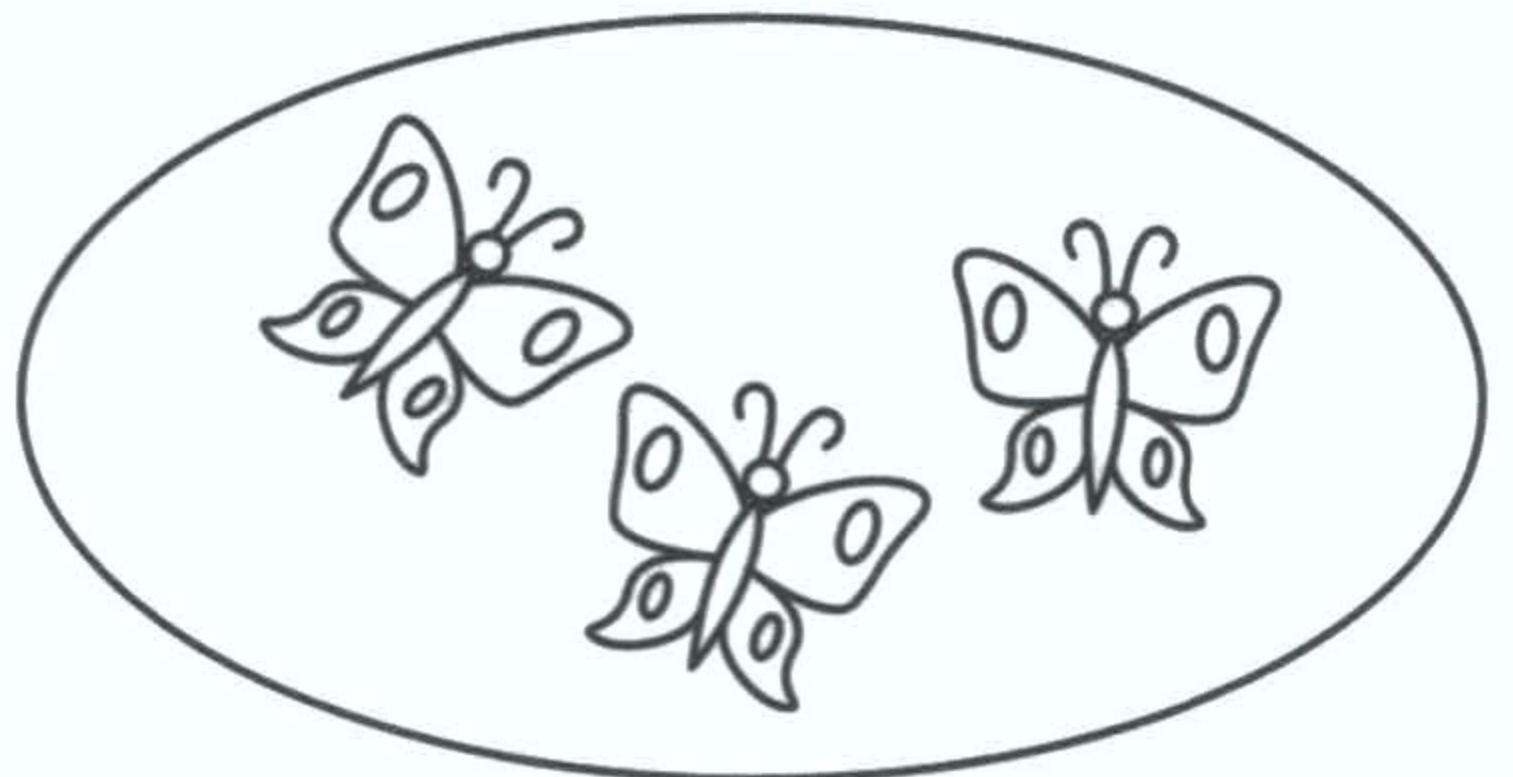
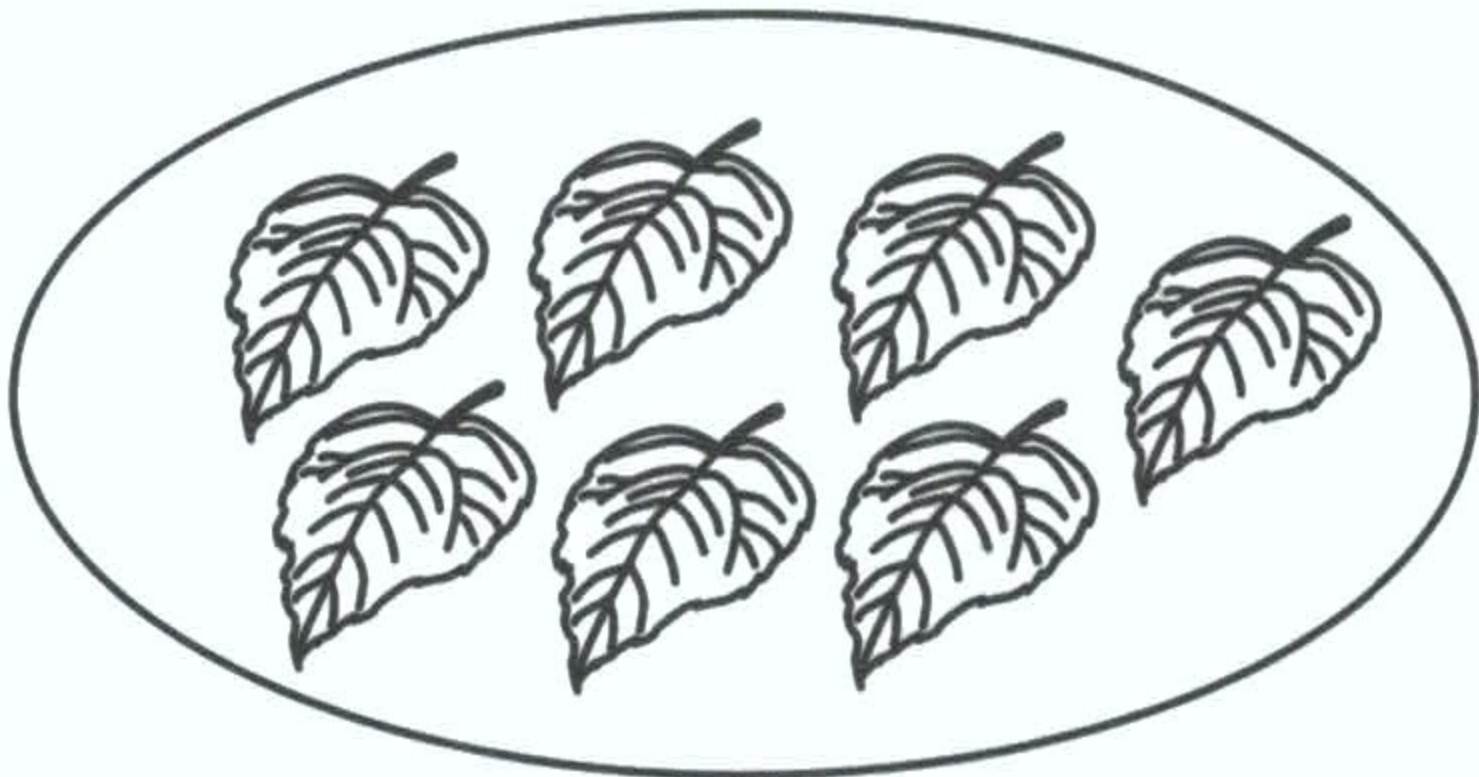
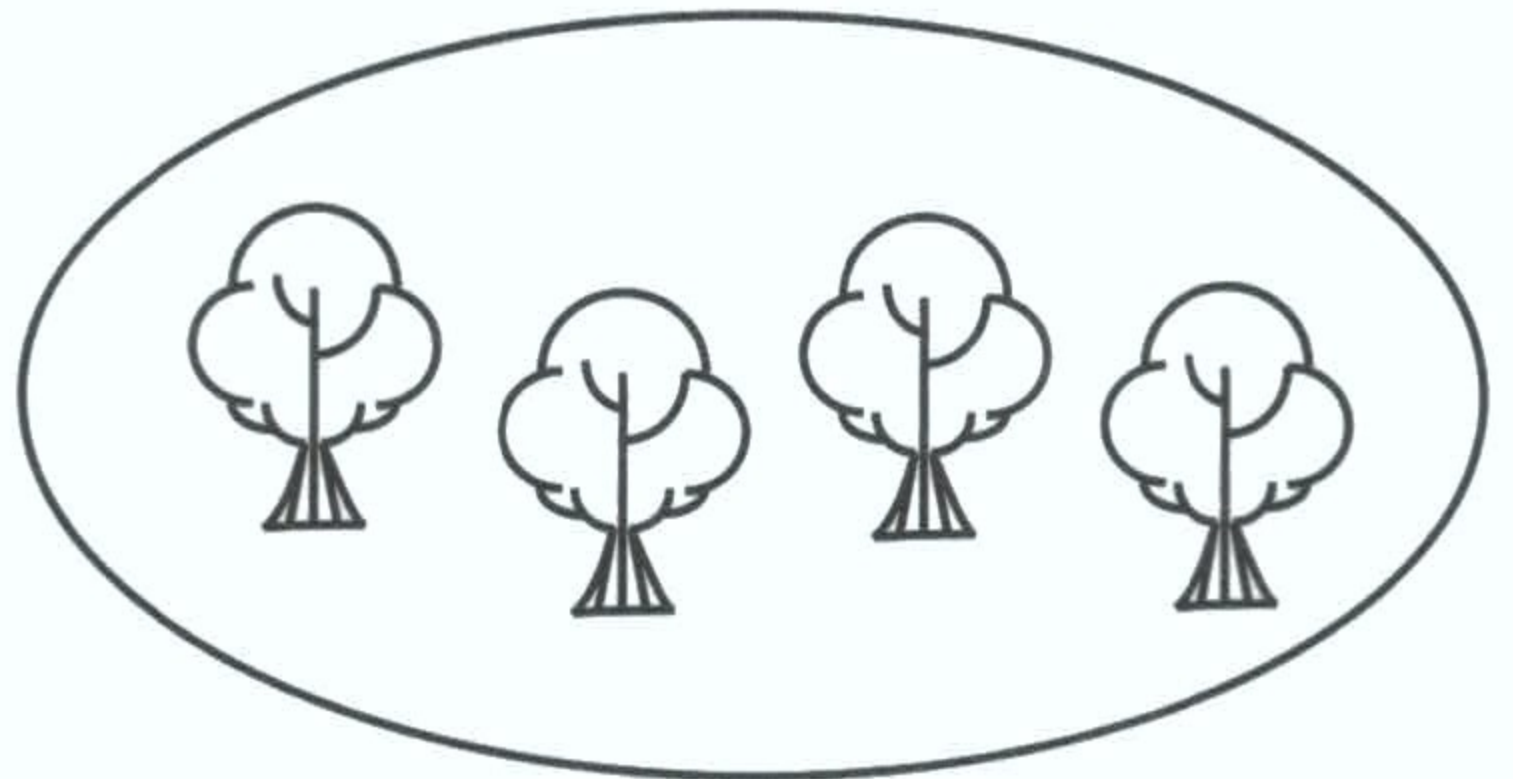
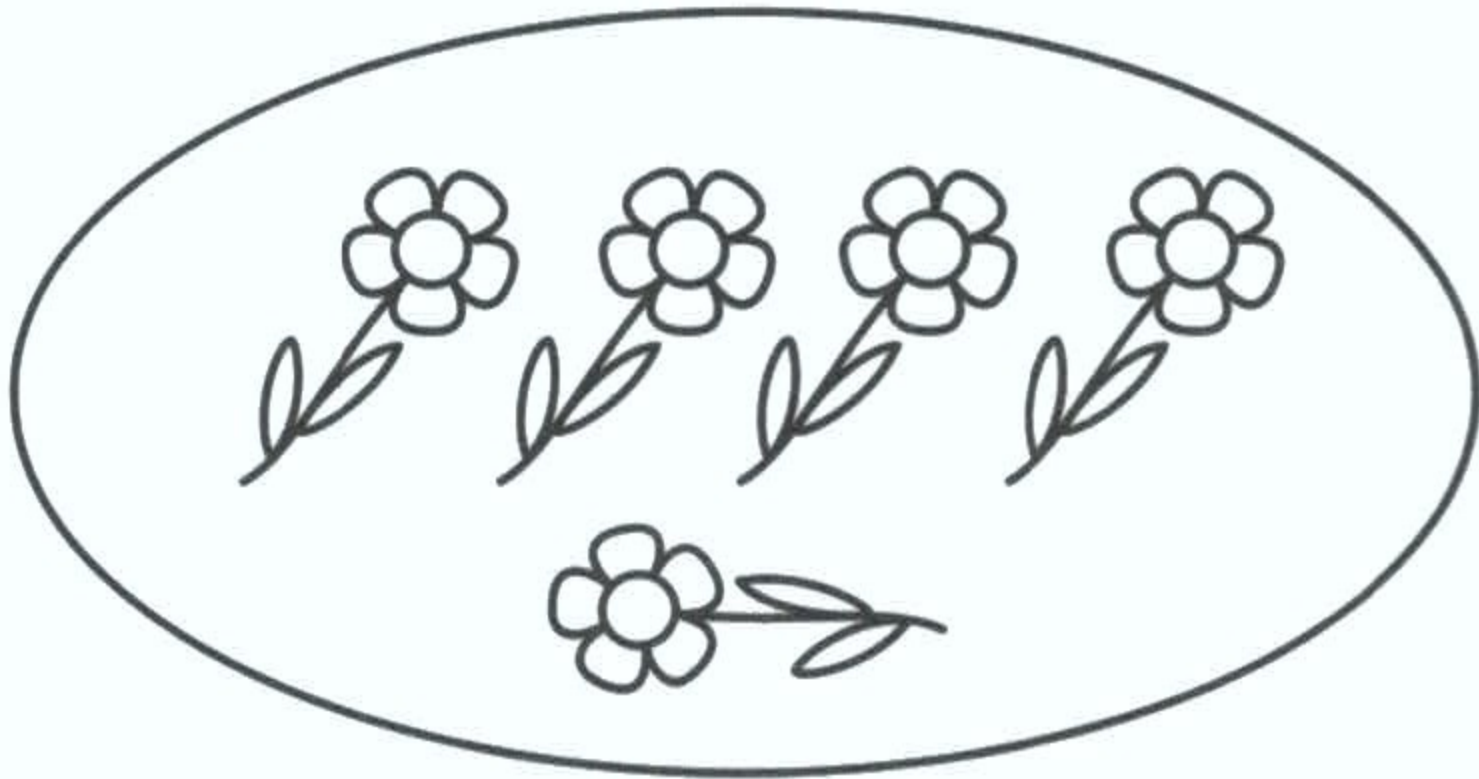
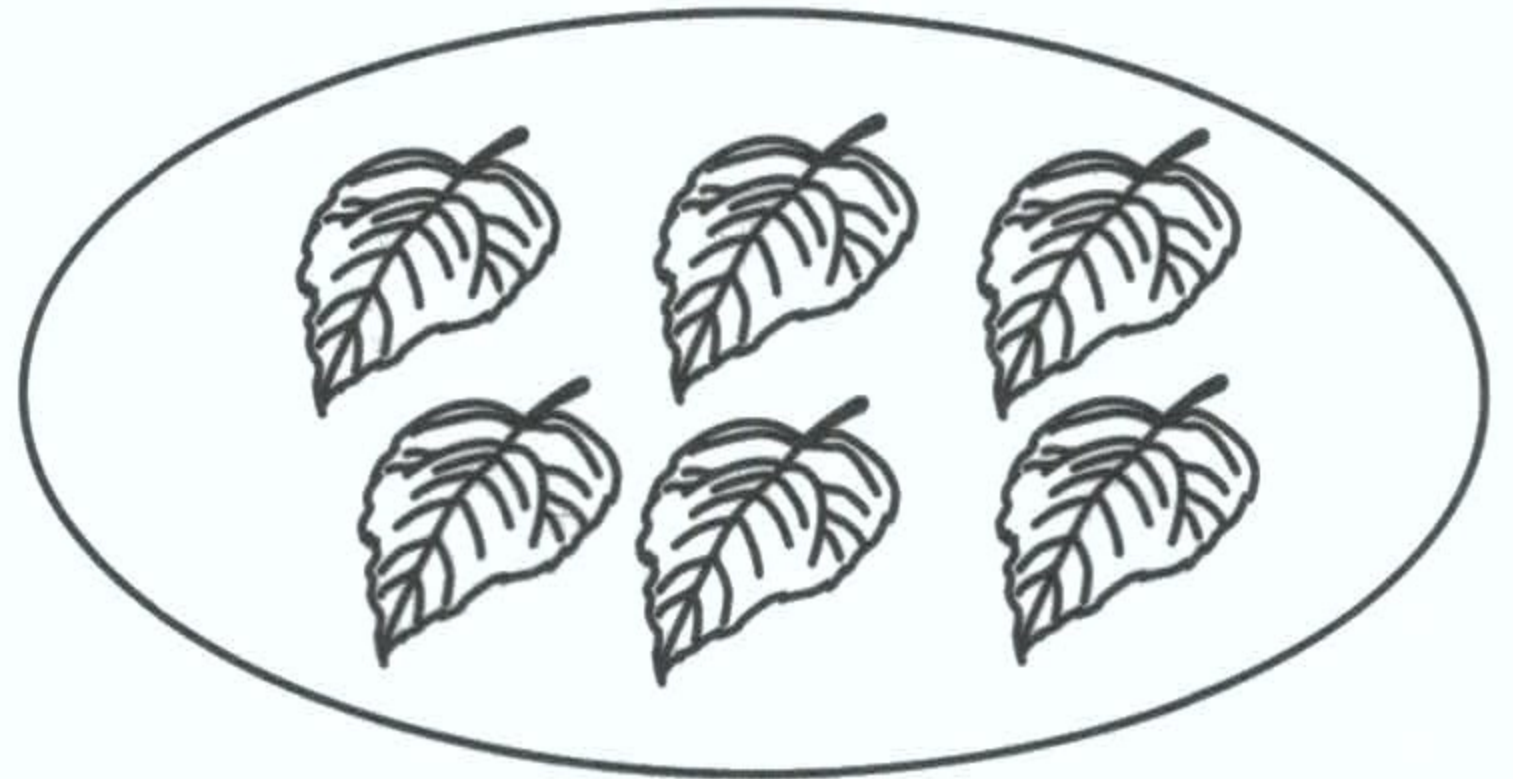
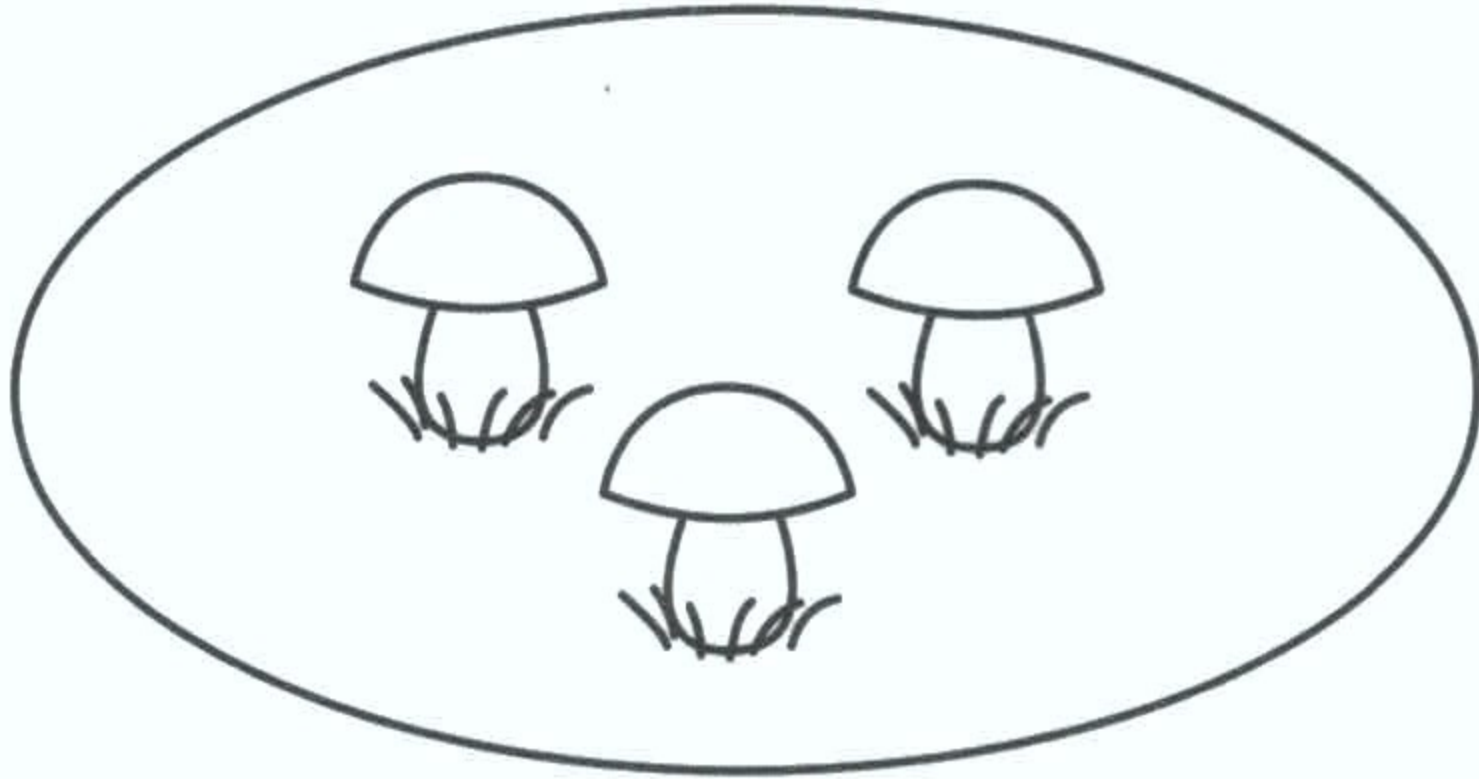
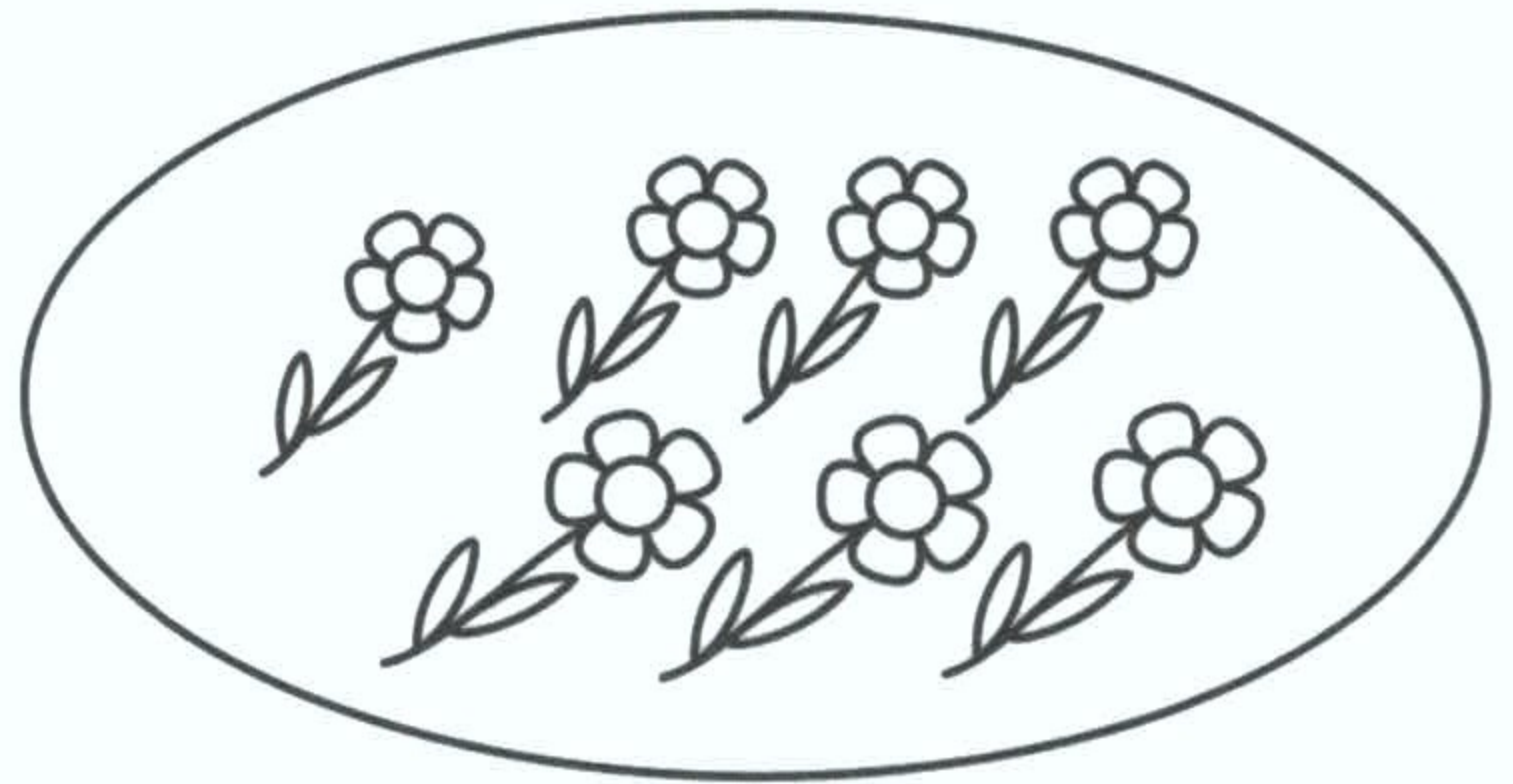
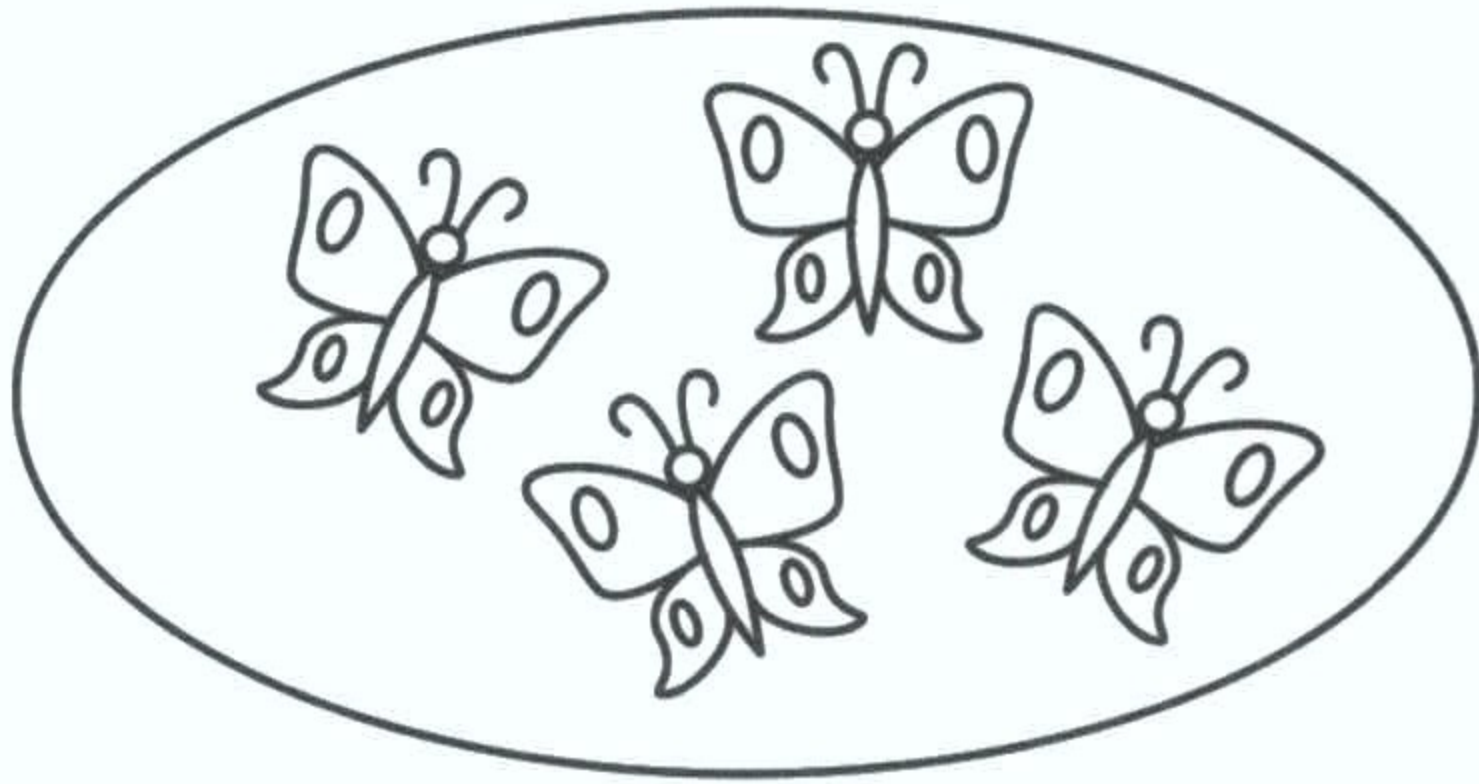

Нарисуй столько предметов, сколько обозначает данная цифра.

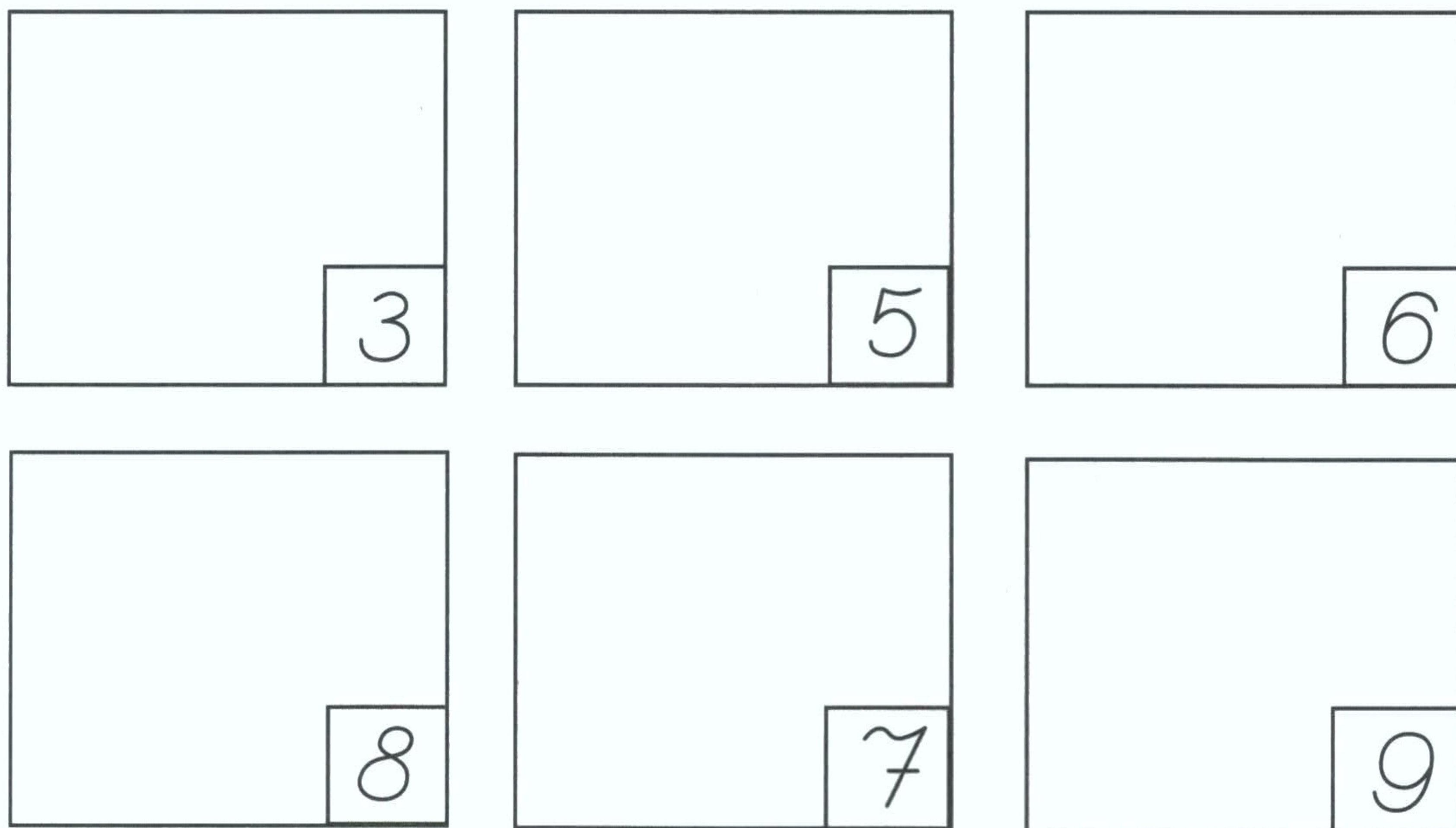

Соедини цифры по точкам в порядке возрастания. Раскрась получившуюся картинку.

6 • 7 •

5 • 4 •

2 • 3 • 8 • 9 •



1

7

3

9

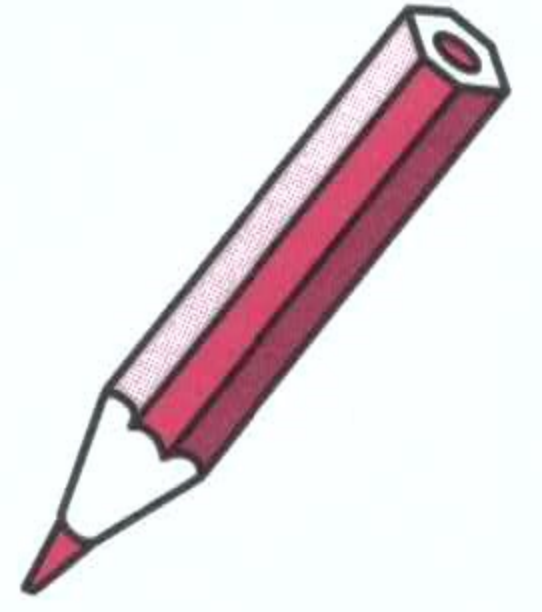

2

8

4

10



3

9

5

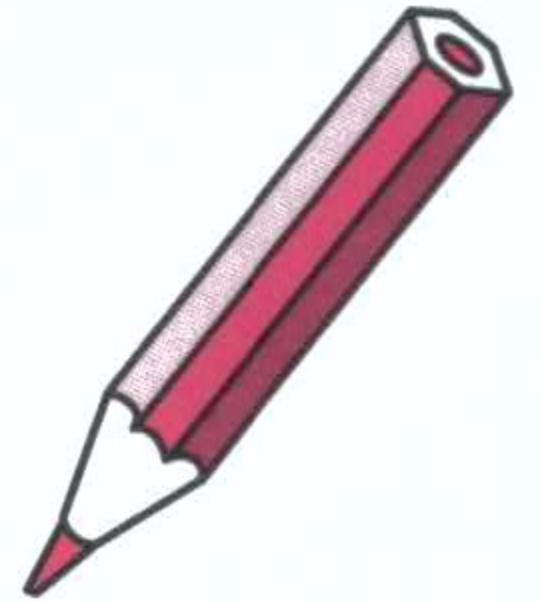

4

10

6



5

1

7



6

2

8

